



US008751313B2

(12) **United States Patent
Fisher**

(10) **Patent No.:** US 8,751,313 B2
(45) **Date of Patent:** *Jun. 10, 2014

(54) **SINGLE TAP TRANSACTIONS USING A
MOBILE APPLICATION**

- (71) Applicant: **Blaze Mobile, Inc.**, Berkeley, CA (US)
- (72) Inventor: **Michelle Fisher**, Oakland, CA (US)
- (73) Assignee: **Michelle Fisher**, Oakland, CA (US)

(*) Notice: Subject to any disclaimer, the term of this patent is extended or adjusted under 35 U.S.C. 154(b) by 0 days.

This patent is subject to a terminal disclaimer.

(21) Appl. No.: **13/680,303**

(22) Filed: **Nov. 19, 2012**

(65) **Prior Publication Data**

US 2013/0080231 A1 Mar. 28, 2013

Related U.S. Application Data

(63) Continuation of application No. 13/338,203, filed on Dec. 27, 2011, now Pat. No. 8,332,272, which is a
(Continued)

(51) **Int. Cl.**

- G06Q 20/00** (2012.01)
- G06Q 40/00** (2012.01)
- G06K 15/00** (2006.01)
- G07F 19/00** (2006.01)
- G06Q 20/20** (2012.01)
- G07F 7/10** (2006.01)

(52) **U.S. Cl.**

- CPC **G06Q 20/20** (2013.01); **G06Q 40/10** (2013.01); **G07F 7/1008** (2013.01)
- USPC **705/16**; 705/18; 705/30; 705/40; 705/41; 705/44; 455/41.1; 455/558; 235/375; 235/379; 235/380; 235/381; 235/383

(58) **Field of Classification Search**

CPC G06Q 20/20; G06Q 20/206; G06Q 40/10; G06Q 20/105; G06Q 20/40; G06Q 30/06; G07F 7/1008; G07F 7/08
USPC 705/14.26, 14.39, 16, 18, 30, 40, 41, 705/44, 39, 67; 455/558, 406, 410; 235/380-383, 439, 441, 451; 725/9, 725/23, 35

See application file for complete search history.

(56) **References Cited**

U.S. PATENT DOCUMENTS

- 6,038,367 A 3/2000 Abecassis
 - 6,101,483 A * 8/2000 Petrovich et al. 705/21
- (Continued)

FOREIGN PATENT DOCUMENTS

- WO WO 2006095212 A1 9/2006
- WO WO 2006095212 A1 * 9/2006 H04M 11/00

OTHER PUBLICATIONS

U.S. Appl. No. 11/933,337, Office Action mailed May 27, 2010, 9 p.
(Continued)

Primary Examiner — Olusegun Goyea

(57) **ABSTRACT**

The invention describes how a consumer can hold their NFC enabled device in proximity to an NFC enabled point-of-sale terminal and with a single “wave” or “tap” to automatically redeem coupons, pay for a purchase using a default payment card or a selected card, view receipts view reward point balances, and receive relevant coupons and other digital artifacts both before and after the purchase. The NFC enabled device includes a secure element with a payment application, payment credentials, and other digital artifacts such as coupons. The secure element can be internal to the mobile device, externally affixed to the mobile device, or inserted into a slot within the body of the mobile device.

20 Claims, 17 Drawing Sheets

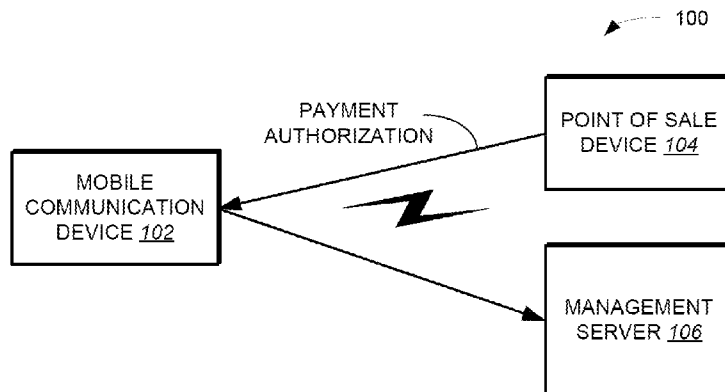

Related U.S. Application Data

continuation of application No. 11/948,903, filed on Nov. 30, 2007, now Pat. No. 8,352,323, and a continuation of application No. 11/956,261, filed on Dec. 13, 2007, and a continuation of application No. 11/467,441, filed on Aug. 25, 2006, now abandoned, and a continuation of application No. 12/592,581, filed on Nov. 25, 2009, and a continuation of application No. 11/939,821, filed on Nov. 14, 2007, now Pat. No. 8,290,433, and a continuation of application No. 11/944,267, filed on Nov. 21, 2007, and a continuation of application No. 11/933,321, filed on Oct. 31, 2007, now Pat. No. 8,275,312, which is a continuation-in-part of application No. 11/467,441, filed on Aug. 25, 2006, now abandoned.

(56)

References Cited

U.S. PATENT DOCUMENTS

6,115,601	A *	9/2000	Ferreira	455/406
6,123,259	A *	9/2000	Ogasawara	235/380
6,128,655	A	10/2000	Fields	
6,141,666	A	10/2000	Tobin	
6,199,082	B1	3/2001	Ferrel	
6,250,557	B1 *	6/2001	Forslund et al.	235/492
6,415,156	B1	7/2002	Stadelmann	
6,450,407	B1 *	9/2002	Freeman et al.	235/492
6,587,835	B1 *	7/2003	Treyz et al.	705/14.64
6,605,120	B1	8/2003	Fields	
6,771,981	B1	8/2004	Zalewski	
6,772,396	B1	8/2004	Cronin	
6,886,017	B1	4/2005	Jackson	
6,950,939	B2	9/2005	Tobin	
7,031,945	B1	4/2006	Donner	
7,069,248	B2	6/2006	Huber	
7,096,003	B2	8/2006	Joao	
7,110,744	B2	9/2006	Freeny	
7,110,792	B2 *	9/2006	Rosenberg	455/558
7,127,236	B2	10/2006	Khan	
7,188,089	B2	3/2007	Goldthwaite	
7,200,578	B2 *	4/2007	Paltenghe et al.	705/74
7,289,810	B2	10/2007	Jagadeesan	
7,308,254	B1	12/2007	Rissanen	
7,512,567	B2 *	3/2009	Bemmel et al.	705/67
7,522,905	B2	4/2009	Hammad	
7,784,684	B2 *	8/2010	Labrou et al.	235/380
7,870,077	B2 *	1/2011	Woo et al.	705/78
7,979,519	B2 *	7/2011	Shigeta et al.	709/223
8,005,426	B2 *	8/2011	Huomo et al.	455/41.2
8,019,362	B2 *	9/2011	Sweatman et al.	455/466
8,073,424	B2 *	12/2011	Sun et al.	455/406
8,086,534	B2 *	12/2011	Powell	705/44
8,109,444	B2 *	2/2012	Jain	235/492
8,127,984	B2 *	3/2012	Zatloukal et al.	235/380
8,214,454	B1 *	7/2012	Barnes et al.	709/217
2001/0011250	A1 *	8/2001	Paltenghe et al.	705/41
2001/0044751	A1 *	11/2001	Pugliese et al.	705/26
2002/0056091	A1 *	5/2002	Bala et al.	725/34
2002/0065774	A1 *	5/2002	Young et al.	705/41
2002/0077918	A1	6/2002	Lerner	
2002/0082879	A1	6/2002	Miller	
2002/0107756	A1	8/2002	Hammons	
2002/0116269	A1 *	8/2002	Ishida	705/14
2002/0160761	A1 *	10/2002	Wolfe	455/414
2002/0169984	A1	11/2002	Kumar	
2003/0061113	A1 *	3/2003	Petrovich et al.	705/26
2003/0065805	A1	4/2003	Barnes	
2003/0074259	A1 *	4/2003	Slyman et al.	705/14
2003/0085286	A1 *	5/2003	Kelley et al.	235/492
2003/0087601	A1 *	5/2003	Agam et al.	455/39
2003/0093695	A1	5/2003	Dutta	
2003/0105641	A1	6/2003	Lewis	
2003/0132298	A1 *	7/2003	Swartz et al.	235/472.02
2003/0163359	A1 *	8/2003	Kanesaka	705/8

2003/0172028	A1	9/2003	Abell	
2004/0006497	A1	1/2004	Nestor	
2004/0030658	A1	2/2004	Cruz	
2004/0073497	A1 *	4/2004	Hayes et al.	705/27
2004/0127256	A1 *	7/2004	Goldthwaite et al.	455/558
2004/0235450	A1 *	11/2004	Rosenberg	455/406
2004/0243519	A1	12/2004	Perttila	
2004/0254836	A1 *	12/2004	Emoke Barabas et al.	705/14
2004/0267618	A1	12/2004	Judicibus	
2005/0040230	A1 *	2/2005	Swartz et al.	235/383
2005/0076210	A1	4/2005	Thomas	
2005/0109841	A1 *	5/2005	Ryan et al.	235/380
2005/0187873	A1 *	8/2005	Labrou et al.	705/40
2005/0215231	A1	9/2005	Bauchot	
2006/0031752	A1 *	2/2006	Surloff et al.	715/501.1
2006/0089874	A1 *	4/2006	Newman et al.	705/14
2006/0143091	A1 *	6/2006	Yuan et al.	705/26
2006/0168261	A1 *	7/2006	Serval et al.	709/230
2006/0191995	A1 *	8/2006	Stewart et al.	235/379
2006/0206709	A1 *	9/2006	Labrou et al.	713/167
2006/0208066	A1 *	9/2006	Finn et al.	235/380
2006/0213972	A1 *	9/2006	Kelley et al.	235/380
2006/0219780	A1 *	10/2006	Swartz et al.	235/383
2006/0266822	A1 *	11/2006	Kelley et al.	235/380
2006/0287920	A1 *	12/2006	Perkins et al.	705/14
2007/0011099	A1 *	1/2007	Sheehan	705/65
2007/0022058	A1 *	1/2007	Labrou et al.	705/67
2007/0095892	A1	5/2007	Lyons	
2007/0125838	A1 *	6/2007	Law et al.	235/379
2007/0125840	A1 *	6/2007	Law et al.	235/379
2007/0131759	A1 *	6/2007	Cox et al.	235/380
2007/0138299	A1 *	6/2007	Mitra	235/492
2007/0156436	A1 *	7/2007	Fisher et al.	705/1
2007/0210155	A1 *	9/2007	Swartz et al.	235/383
2007/0252010	A1 *	11/2007	Gonzalez et al.	235/492
2007/0255662	A1	11/2007	Tumminaro	
2007/0270166	A1 *	11/2007	Hampel et al.	455/456.3
2007/0293155	A1 *	12/2007	Liao et al.	455/41.2
2008/0010196	A1 *	1/2008	Rackley, III et al.	705/40
2008/0011833	A1 *	1/2008	Saarialo	235/382
2008/0017704	A1 *	1/2008	VanDeburg et al.	235/380
2008/0045172	A1 *	2/2008	Narayanaswami et al.	455/187.1
2008/0048022	A1 *	2/2008	Vawter	235/380
2008/0051059	A1 *	2/2008	Fisher	455/410
2008/0051142	A1 *	2/2008	Calvet et al.	455/558
2008/0052192	A1 *	2/2008	Fisher	705/26
2008/0052233	A1 *	2/2008	Fisher et al.	705/40
2008/0087731	A1 *	4/2008	Gonzalez et al.	235/441
2008/0139155	A1	6/2008	Boireau	
2008/0148040	A1 *	6/2008	Machani et al.	713/150
2008/0167988	A1 *	7/2008	Sun et al.	705/39
2008/0177668	A1	7/2008	Delean	
2008/0207128	A1 *	8/2008	Mikko	455/41.2
2008/0207234	A1 *	8/2008	Arthur et al.	455/466
2008/0208681	A1	8/2008	Hammad	
2008/0208743	A1 *	8/2008	Arthur et al.	705/41
2008/0208744	A1 *	8/2008	Arthur et al.	705/41
2008/0208762	A1 *	8/2008	Arthur et al.	705/79
2008/0221997	A1 *	9/2008	Wolfe	705/14
2008/0255947	A1 *	10/2008	Friedman	705/14
2008/0262928	A1 *	10/2008	Michaelis	705/14
2008/0275779	A1 *	11/2008	Lakshminarayanan	705/14
2008/0294556	A1	11/2008	Anderson	
2008/0305774	A1	12/2008	Ramakrishna	
2009/0063312	A1 *	3/2009	Hurst	705/30
2009/0075592	A1 *	3/2009	Nystrom et al.	455/41.1
2009/0098825	A1 *	4/2009	Huomo et al.	455/41.1
2009/0106112	A1 *	4/2009	Dalmia et al.	705/14
2009/0124234	A1 *	5/2009	Fisher et al.	455/406
2009/0132362	A1 *	5/2009	Fisher et al.	705/14
2009/0143104	A1 *	6/2009	Loh et al.	455/558
2009/0144161	A1 *	6/2009	Fisher	705/16
2009/0177587	A1 *	7/2009	Siegal et al.	705/67
2009/0227281	A1 *	9/2009	Hammad et al.	455/550.1
2009/0291634	A1 *	11/2009	Saarialo	455/41.1
2010/0057619	A1 *	3/2010	Weller et al.	705/67
2010/0063895	A1 *	3/2010	Dominguez et al.	705/26
2011/0320316	A1 *	12/2011	Randazza et al.	705/26.43

(56)

References Cited

U.S. PATENT DOCUMENTS

2012/0022902	A1 *	1/2012	Gressel et al.	705/5
2012/0030044	A1 *	2/2012	Hurst	705/18
2012/0123847	A1 *	5/2012	Wane et al.	705/14.26
2012/0130839	A1 *	5/2012	Koh et al.	705/26.1
2012/0322375	A1 *	12/2012	Hirsch	455/41.1
2013/0054470	A1 *	2/2013	Campos et al.	705/67
2013/0092741	A1 *	4/2013	Loh et al.	235/492

OTHER PUBLICATIONS

U.S. Appl. No. 11/933,351, Office Action mailed Oct. 3, 2008, 5 p.
U.S. Appl. No. 11/933,367, Office Action mailed May 27, 2010, 8 p.
U.S. Appl. No. 11/467,441, Office Action mailed May 27, 2009, 17 p.
U.S. Appl. No. 12/592,581, Office Action mailed Jun. 4, 2010, 20 p.

U.S. Appl. No. 11/933,351, Office Action mailed Jul. 8, 2009, 7 p.
U.S. Appl. No. 11/939,821, Office Action mailed Aug. 17, 2010, 11 p.
U.S. Appl. No. 11/933,351, Office Action mailed Aug. 18, 2010, 16 p.
U.S. Appl. No. 11/933,321, Office Action mailed May 27, 2010, 11 p.
U.S. Appl. No. 11/948,903, Office Action mailed Feb. 2, 2009, 11 p.
U.S. Appl. No. 11/948,903, Office Action mailed Nov. 12, 2009, 14 p.
Deena, M. Amato, "Mobile Rewards." Chain Store Age 82.5 (2006): 160, 161, 163. Hoover's Company Profiles; ProQuest Central. Web. Oct. 5, 2012.
"ViVOtech to Demonstrate Industry's First End-to-End Near Field Communication (NFC) Solution at the NRF Show." Business Wire: 1 Jan. 16, 2006. Business Dateline; Hoover's Company Profiles; ProQuest Central. Web. Oct. 5, 2012.
Marsh, David. "Get Smart." EDN 48.6 (2003): 61-8. Hoover's Company Profiles; ProQuest Central. Web. Oct. 5, 2012.

* cited by examiner

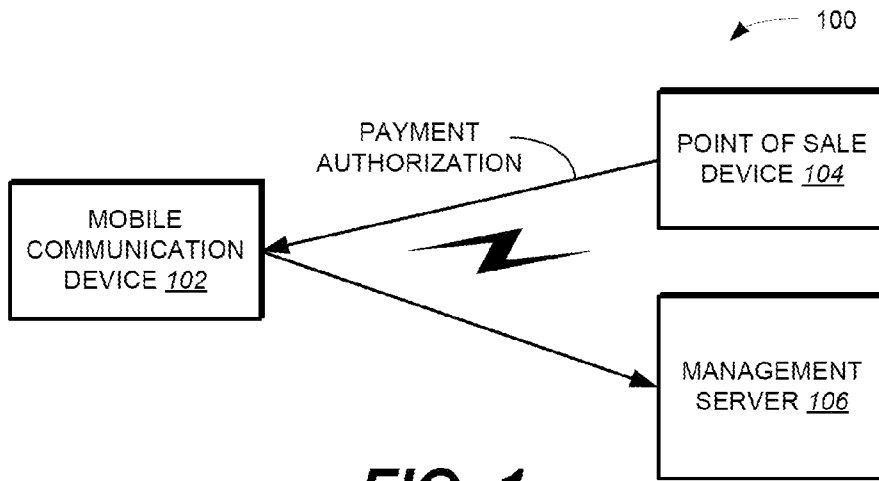

FIG. 1

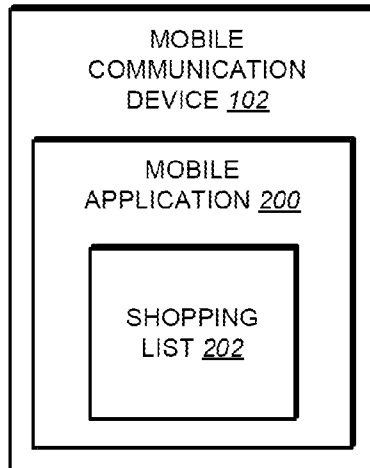

FIG. 2

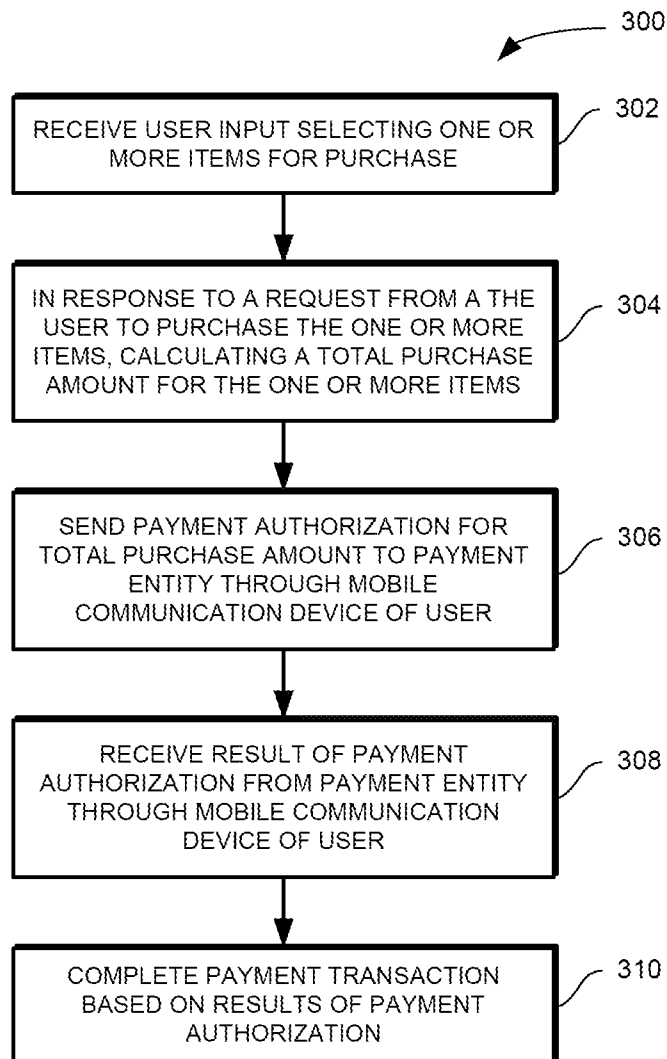

FIG. 3

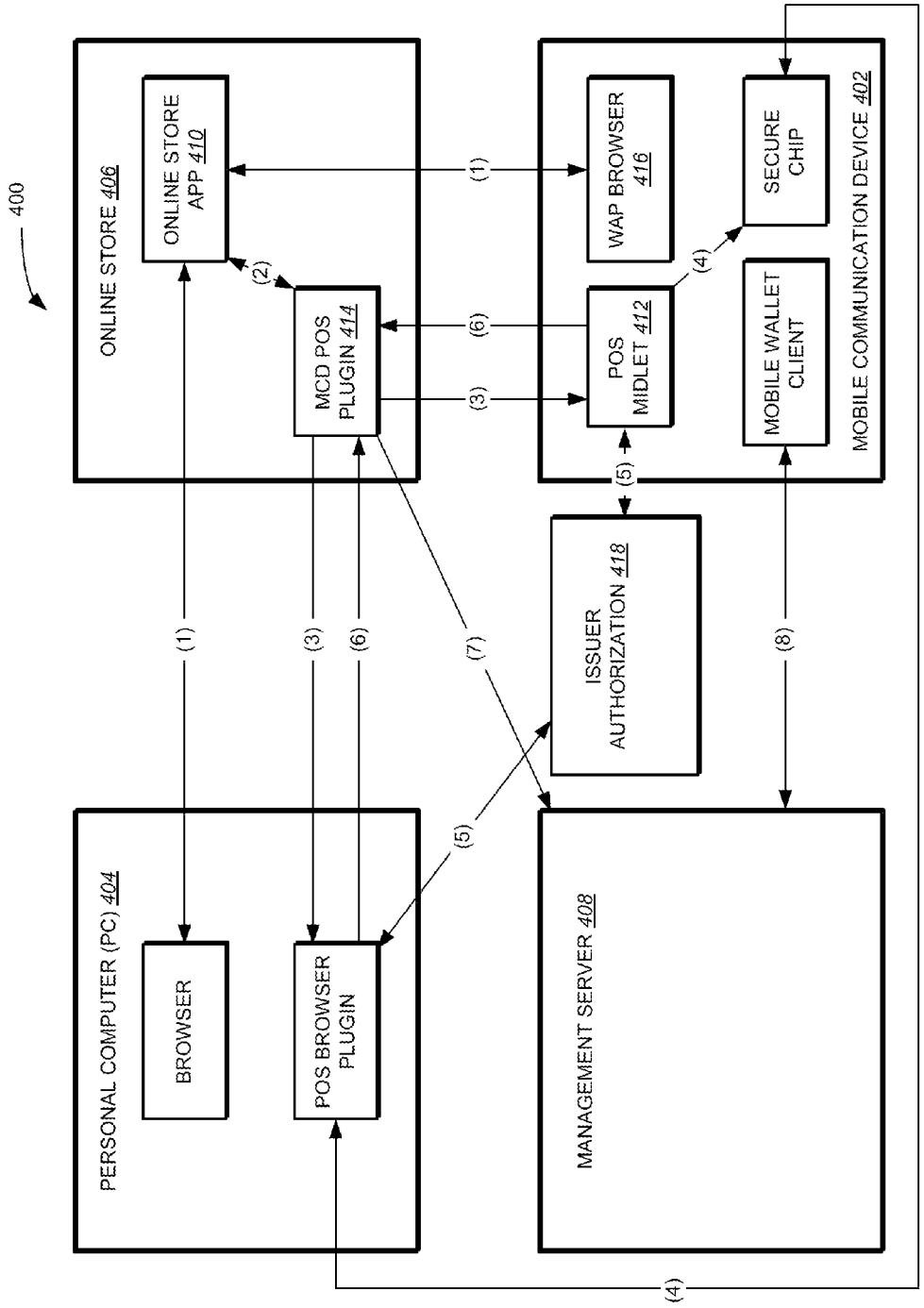

FIG. 4

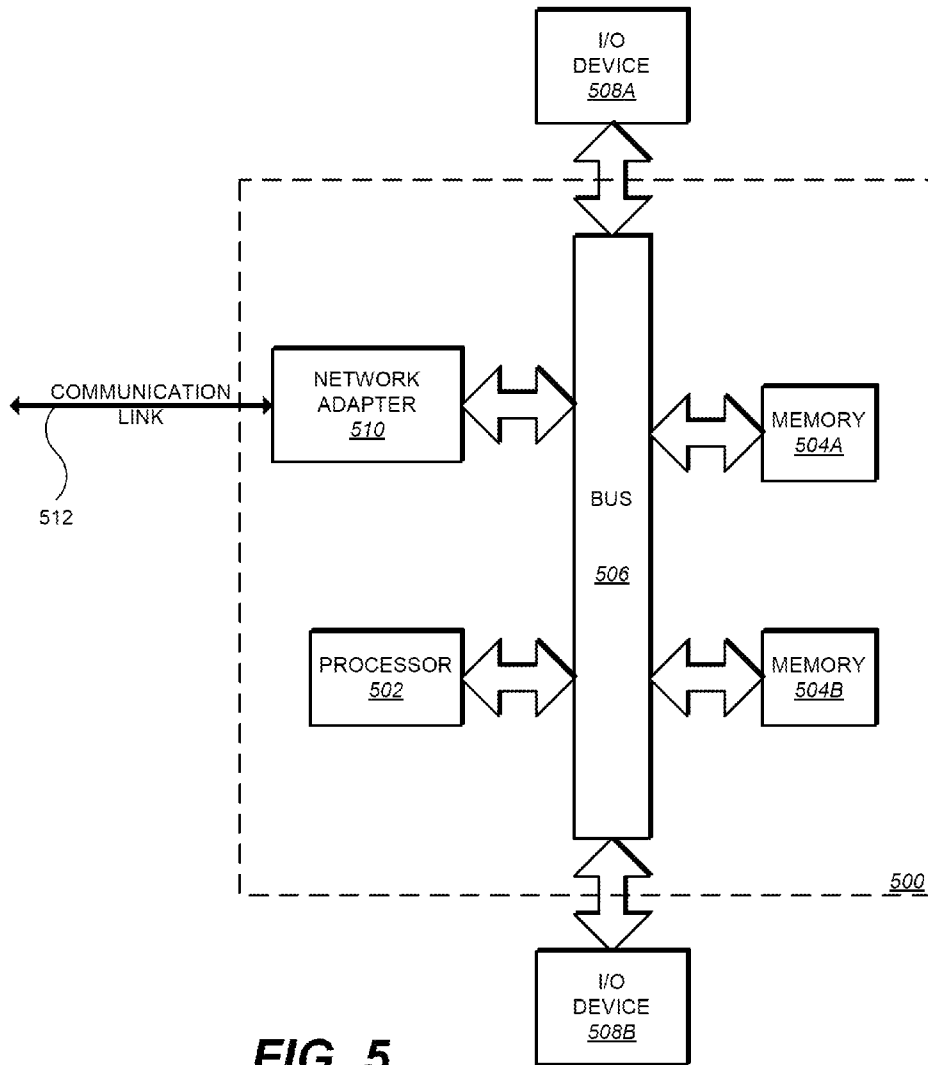

FIG. 5

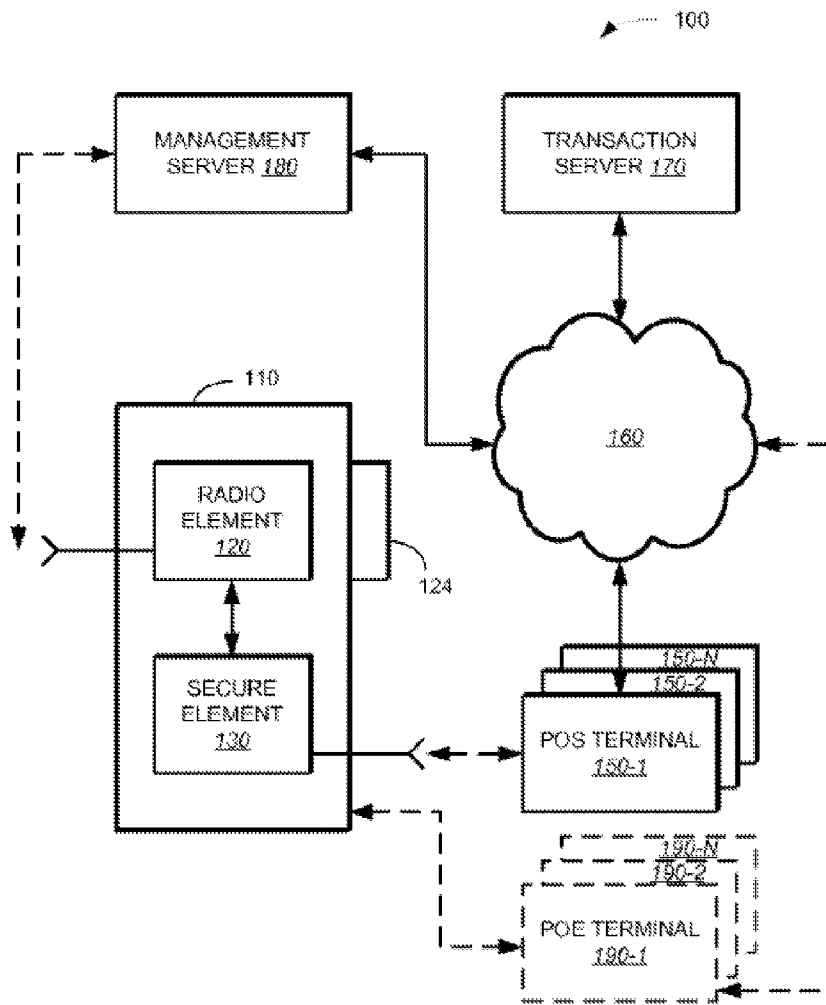

FIGURE 6

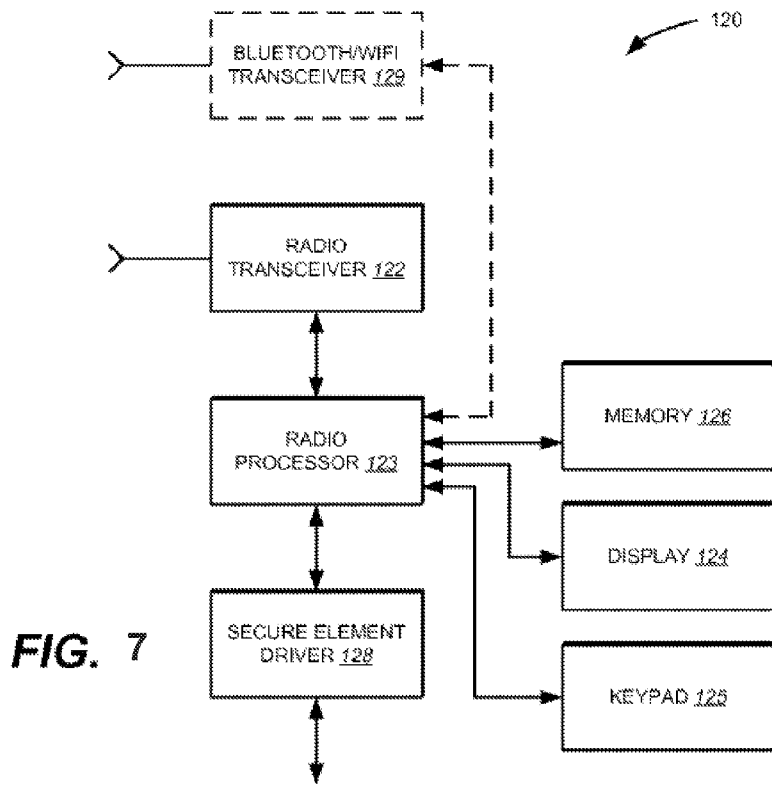

FIG. 7

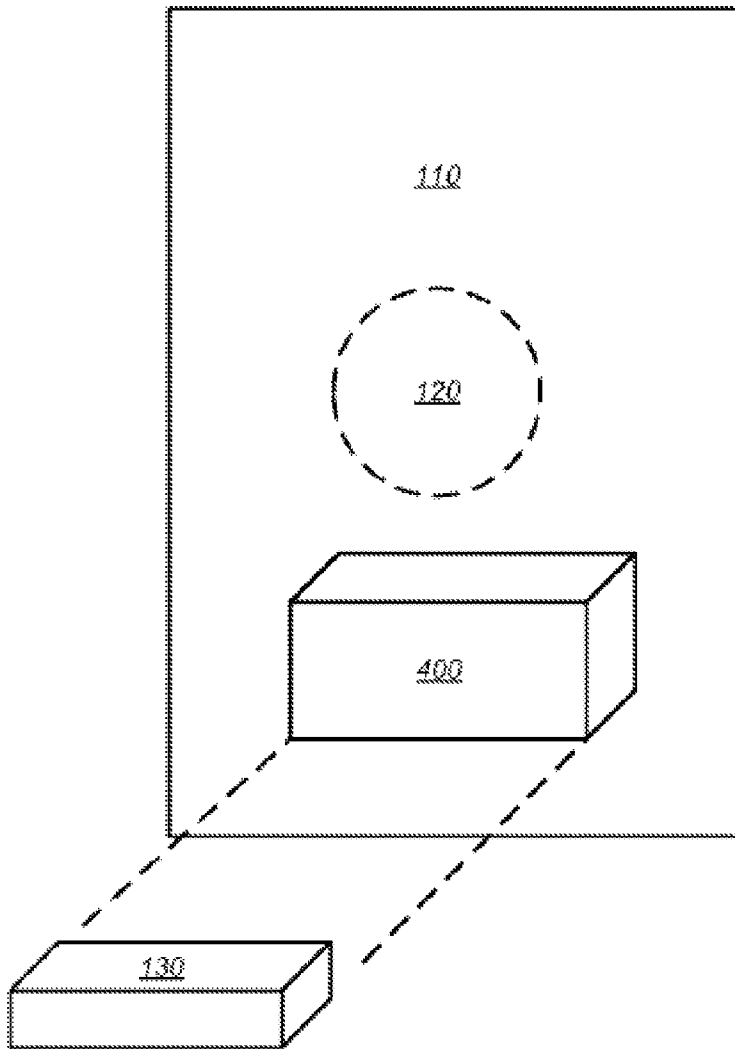

FIGURE 8

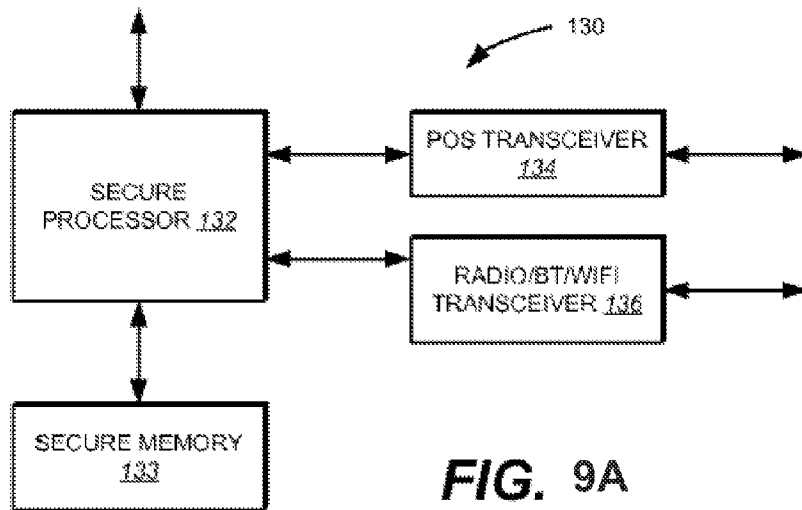

FIG. 9A

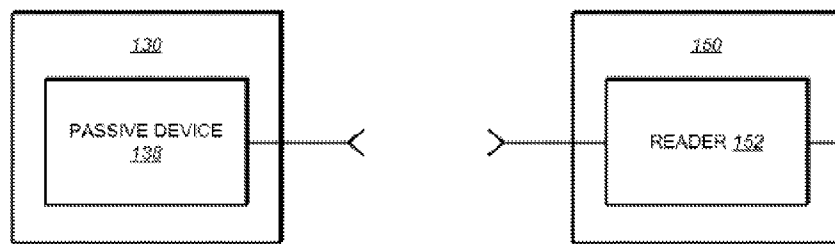
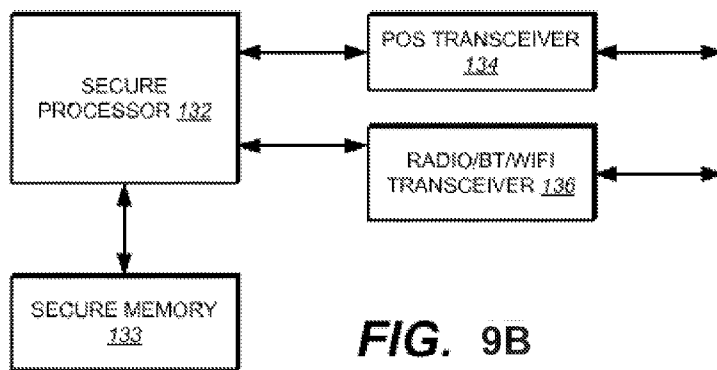

FIGURE 9C

FIGURE 10

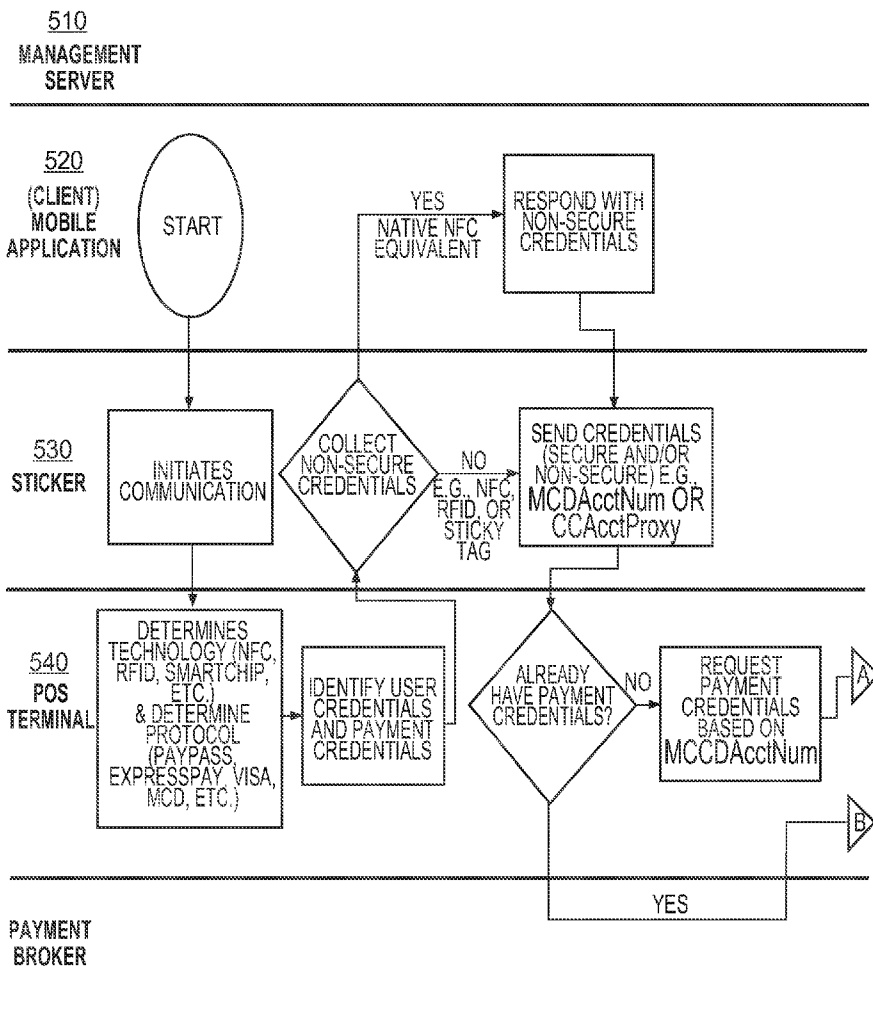

FIG. 11A

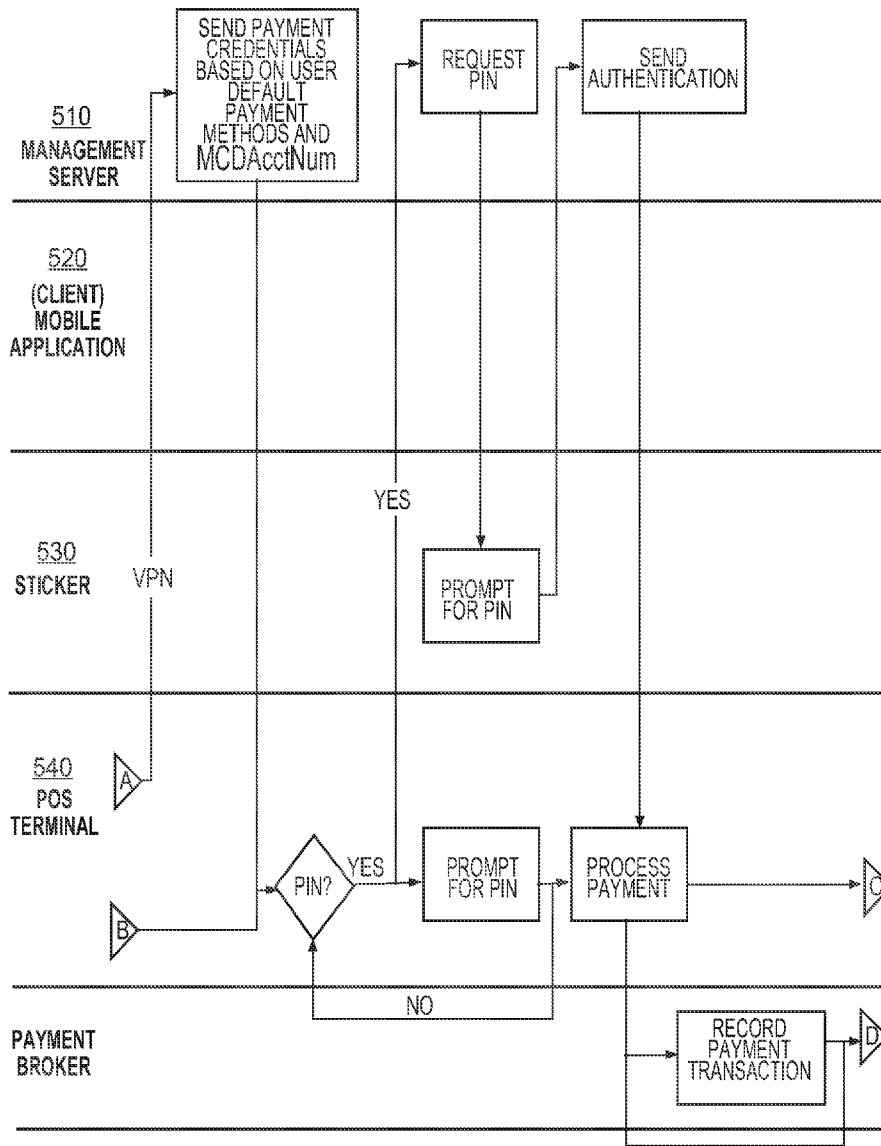

FIG. 11B

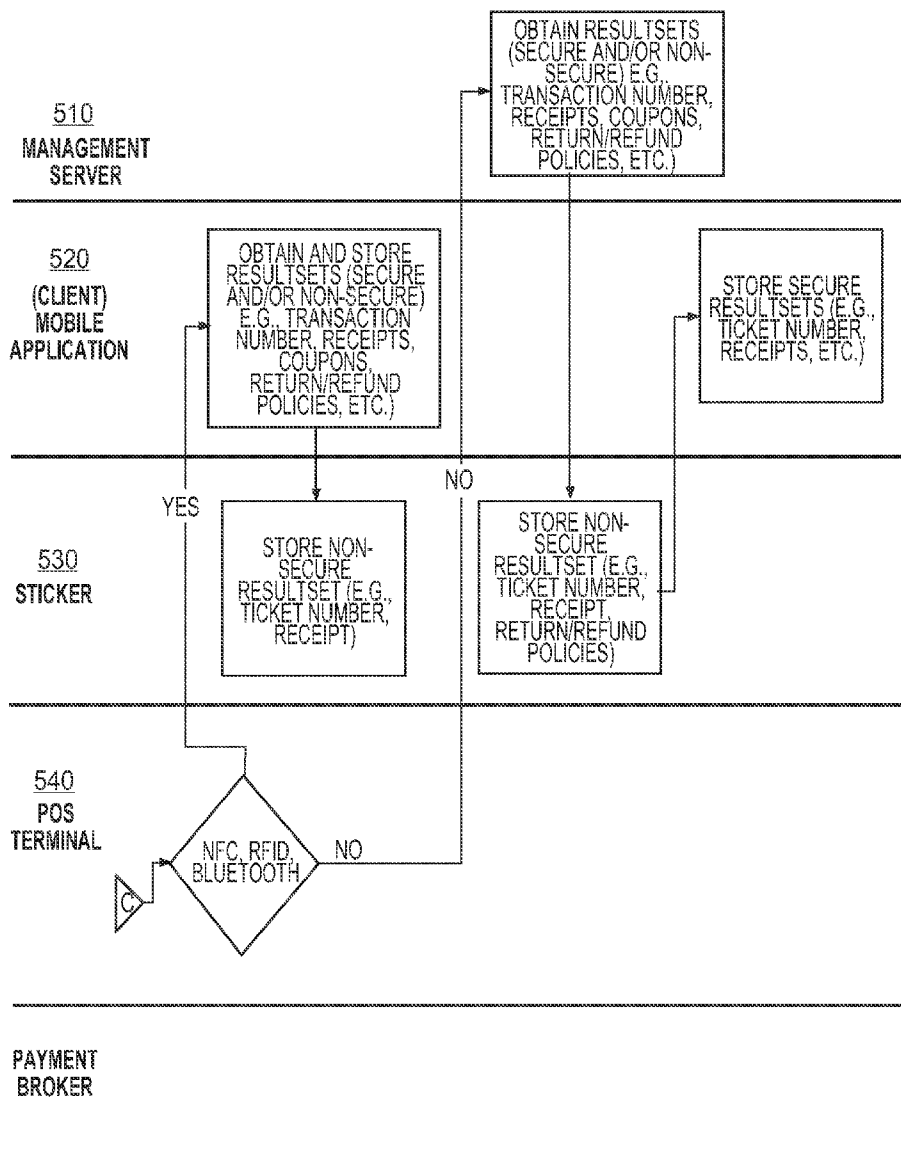

FIG. 11C

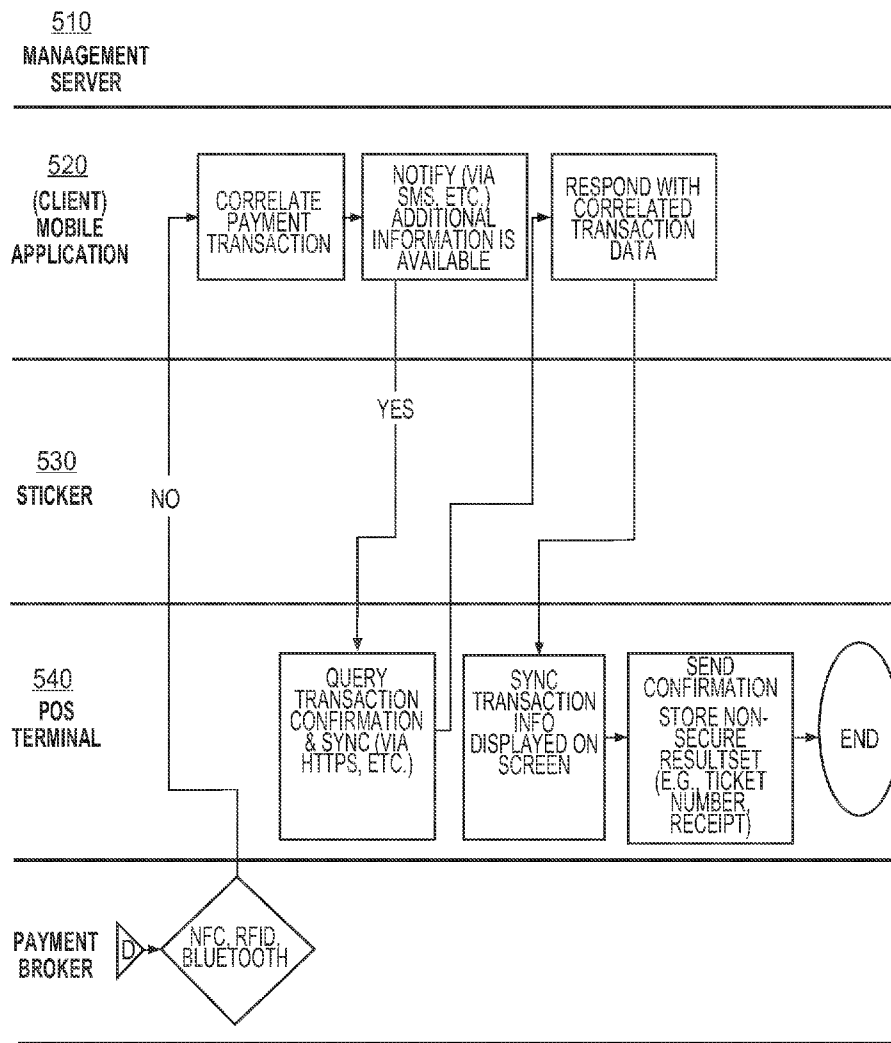

FIG. 11D

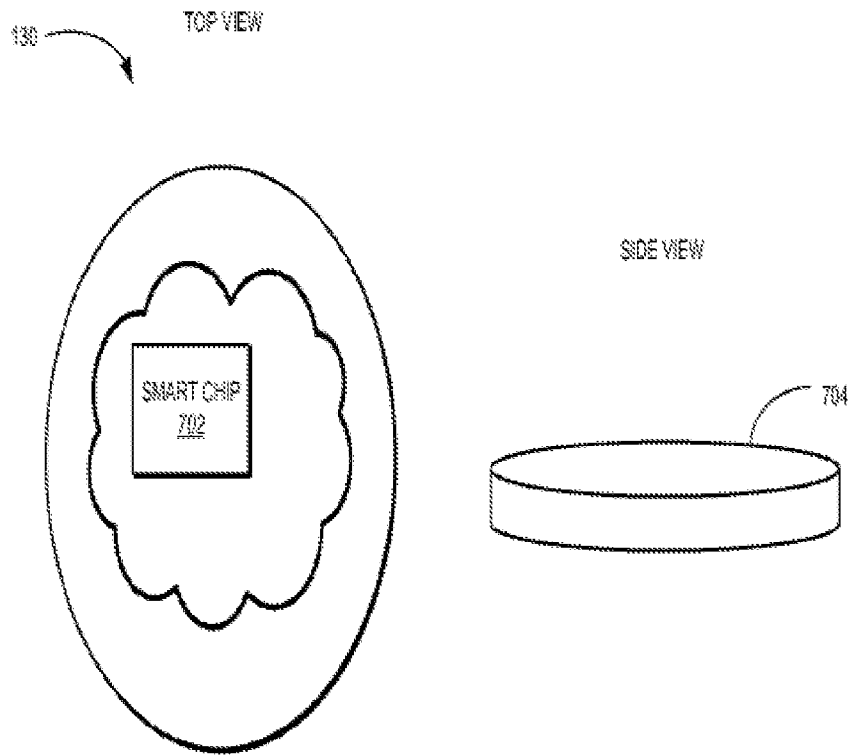

FIGURE 12

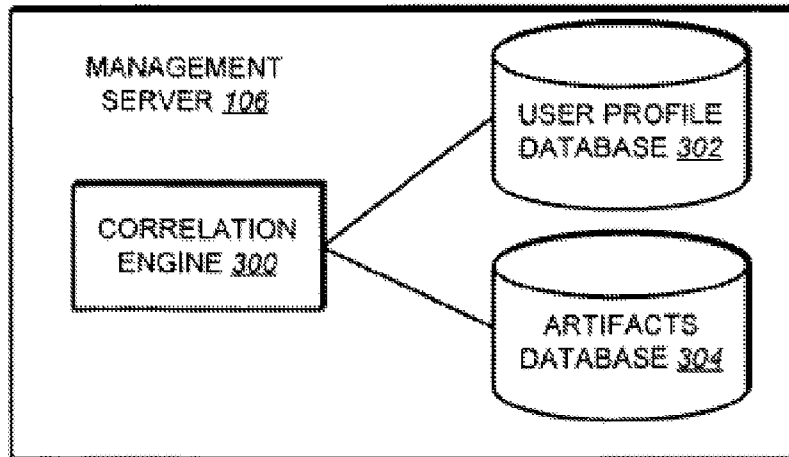

FIGURE 13

400

	CRITERIA 1	CRITERIA 2	CRITERIA 3	CRITERIA 4
USER 1	X			X
USER 2	X	X		X

FIGURE 14

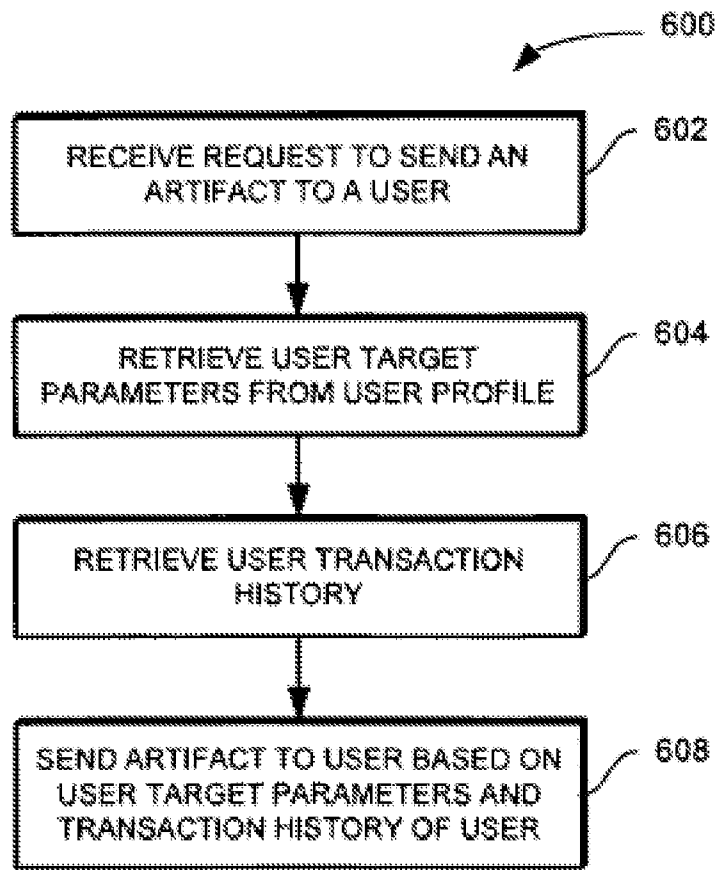

FIGURE 15

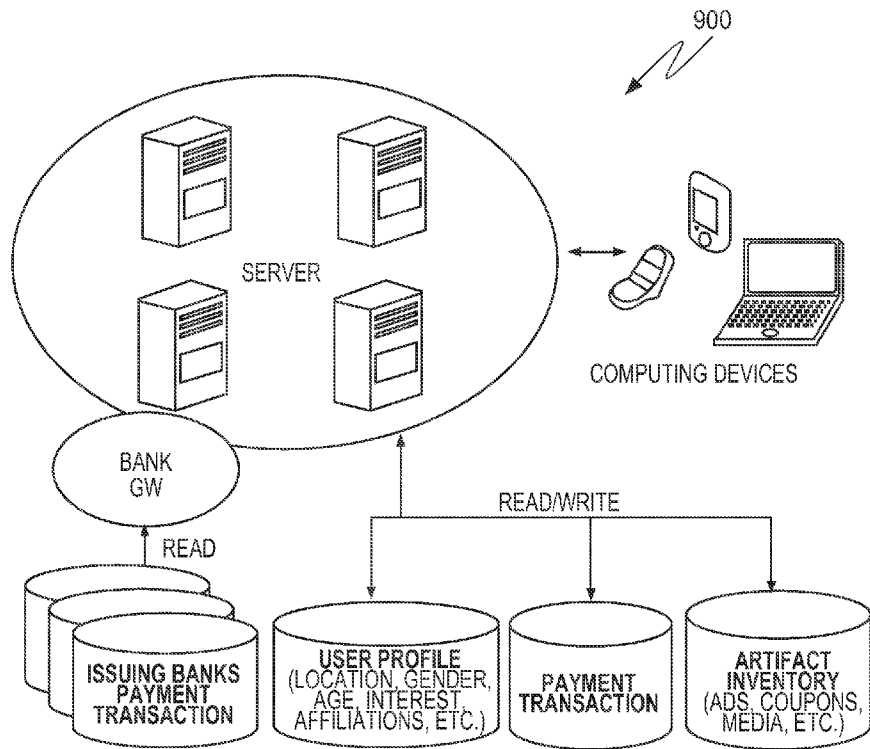

FIG. 16

SINGLE TAP TRANSACTIONS USING A MOBILE APPLICATION

CROSS REFERENCE TO RELATED APPLICATIONS/PRIORITY CLAIMS

This application is a continuation of and claims priority under 35 USC 120 to U.S. patent application Ser. No. 13/338,203, entitled "Single Tap Transactions Using an NFC Enabled Mobile Device", filed on Dec. 27, 2011, which is a continuation of and claims priority under 35 USC 120 to U.S. patent application Ser. No. 11/948,903, entitled "Method And System For Conducting An Online Payment Transaction Using A Mobile Communication Device", filed on Nov. 30, 2007; and is a continuation of and claims priority under 35 USC 120 to U.S. patent application Ser. No. 11/956,261, entitled, "Method and System for Delivering Customized Information To A Mobile Communication Device Based on User Affiliations", filed on Dec. 13, 2007; and is a continuation of and claims priority under 35 USC 120 to U.S. patent application Ser. No. 11/467,441, entitled "Method and Apparatus For Completing A Transaction Using A Wireless Mobile Communication Channel and Another Communication Channel", filed on Aug. 25, 2006; and is a continuation of and claims priority under 35 USC 120 to U.S. patent application Ser. No. 12/592,581, entitled "Method and Apparatus For Completing A Transaction Using A Wireless Mobile Communication Channel and Another Communication Channel", filed on Nov. 25, 2009; and is a continuation of and claims priority under 35 USC 120 to U.S. patent application Ser. No. 11/939,821, entitled "Method and System for Securing Transactions Made Through a Mobile Communication Device", filed on Nov. 14, 2007, now U.S. Pat. No. 8,290,433; and is a continuation of and claims priority under 35 USC 120 to U.S. patent application Ser. No. 11/944,267, entitled "Method And System For Delivering Information To A Mobile Communication Device Based On Consumer Transactions", filed on Nov. 21, 2007; and is a continuation of and claims priority under 35 USC 120 to U.S. patent application Ser. No. 11/933,321, entitled "Induction Triggered Transactions Using an External NFC Device", filed Oct. 31, 2007, now U.S. Pat. No. 8,275,312, which is a Continuation-in-part of and claims priority under 35 USC 120 to U.S. patent application Ser. No. 11/467,441, entitled "Method and Apparatus for Completing a Transaction Using A Wireless Mobile Communication Channel and Another Communication Channel", filed Aug. 25, 2006, now abandoned; the entirety of all of which are incorporated herein by reference.

FIELD OF THE INVENTION

The present invention relates to data communications and wireless devices.

BACKGROUND OF THE INVENTION

Mobile communication devices—e.g., cellular phones, personal digital assistants, and the like—are increasingly being used to conduct payment transactions as described in U.S. patent application Ser. No. 11/933,351, entitled "Method and System For Scheduling A Banking Transaction Through A Mobile Communication Device", and U.S. patent application Ser. No. 11/467,441, entitled "Method and Apparatus For Completing A Transaction Using A Wireless Mobile Communication Channel and Another Communication Channel", both of which are incorporated herein by reference. Such payment transactions can include, for example, pur-

chasing goods and/or services, bill payments, and transferring funds between bank accounts.

BRIEF SUMMARY OF THE INVENTION

In general, this specification describes a method and system for conducting an online payment transaction through a point of sale device. The method includes receiving input from a user selecting an item for purchase through the point of sale device; calculating a total purchase amount for the item in response to a request from the user to purchase the item; and sending payment authorization for the total purchase amount from the point of sale device to a payment entity, in which the payment authorization is sent to the payment entity via a mobile communication device of the user. The method further includes receiving a result of the payment authorization from the payment entity through the mobile communication device; and completing the payment transaction based on the result of the payment authorization.

Particular implementations can include one or more of the following features. The point of sale device can be a desktop computer, a laptop computer, or a terminal. The mobile communication device can be a cellular phone, a wireless personal digital assistant (PDA), or a laptop computer. The cellular phone can be an NFC-enabled phone. Sending payment authorization for the total purchase amount from the point of sale device to a payment entity can include sending the payment authorization securely to the payment entity. The payment entity can be a person, a computer system, or a bank. The method can further include maintaining a shopping list on the mobile communication device of the user, in which the shopping list includes a listing of one or more items to be purchased by the user. The payment authorization can be an authorization for payment with a credit card, a debit card, or a prepaid card.

The details of one or more implementations are set forth in the accompanying drawings and the description below. Other features and advantages will be apparent from the description and drawings, and from the claims.

BRIEF DESCRIPTION OF THE DRAWINGS

FIG. 1 illustrates a block diagram of a communication system including a wireless mobile communication device and a management server in accordance with one implementation.

FIG. 2 illustrates one implementation of the wireless mobile communication device of FIG. 1.

FIG. 3 is a method for conducting a payment transaction using a point of sale device in accordance with one implementation.

FIG. 4 illustrates a block diagram of a communication system including a wireless mobile communication device and an online store in accordance with one implementation.

FIG. 5 is a block diagram of a data processing system suitable for storing and/or executing program code in accordance with one implementation.

FIG. 6 illustrates another implementation of the communication system including a wireless mobile communication device and a management server in accordance with one implementation.

FIG. 7 illustrates an implementation of the radio element of the device in FIG. 6.

FIG. 8 illustrates one implementation of the wireless mobile communications device.

FIGS. 9A-9C respectively illustrate an implementation of a secure element in the wireless mobile communications device of FIG. 1.

FIG. 10 illustrates one implementation of a point of sale terminal.

FIGS. 11A-11D illustrate a flowchart for conducting a transaction according to one implementation.

FIG. 12 illustrates one implementation of a secure element that is attachable to a wireless communications device.

FIG. 13 illustrates one implementation of the management server.

FIG. 14 illustrates one example of the user profile database 302 including user profiles for USER 1 and USER 2

FIG. 15 illustrates one implementation of a method 600 for sending an artifact to a mobile communication device of a user.

FIG. 16 illustrates a block diagram of a communication system including a wireless mobile communication device and a management server in accordance with one implementation.

Like reference symbols in the various drawings indicate like elements.

DETAILED DESCRIPTION OF THE INVENTION

FIG. 1 illustrates one implementation of a communication system 100. The communication system 100 includes a handheld, wireless mobile communication device 102 a point-of-sale device 104 and a management server 106. In one implementation, the mobile communication device 102 includes a mobile application (discussed in greater detail below) that permits a user of the mobile communication device 102 to conduct payment transactions. Payment transactions can include, for example, using contactless payment technology at a retail merchant point of sale (e.g., through point of sale device 104), using mobile/internet commerce (e.g., purchase tickets and products, etc.), storage of payment information and other digital artifacts (e.g., receipts, tickets, coupons, etc.), storage of banking information (payment account numbers, security codes, PIN's, etc.), and accessing banking service (account balance, payment history, bill pay, fund transfer, etc.), and so on. The mobile communication device 102 can be a cellular phone, a wireless personal digital assistant (PDA), a laptop computer, or other wireless communication device. The point of sale device 104 can be a desktop computer, laptop computer, terminal, or other device that is configured to receive user input selecting items for purchase or other transaction.

In one implementation, authorizations for payment transactions that are made through the point of sale device 104 are sent from the point of sale device 104 to an issuer authorization (e.g., management server 106) through the mobile communication device 102 (as shown in FIG. 1). In one implementation, an issuer authorization is a payment entity that either approves or disapproves a payment transaction. An issuer authorization can be, e.g., a person, computer system, bank (or other third party). One potential benefit of having payment authorizations flow through the mobile communication device 102 is that sensitive user information (e.g. account numbers, pin numbers, and/or identity information) need only be sent from the mobile communication device 102 directly to an issuer authorization. Such operation reduces the potential for identity theft and/or fraudulent purchases made through a point of sale device. For example, (in one implementation) payment authorizations cannot be sent to an issuer authorization if the mobile communication device 102 is turned off.

FIG. 2 illustrates one implementation of the mobile communication device 102. The mobile communication device 102 includes a mobile application 200 that (in one implementation) is provided to the mobile communication device 102 through a remote server (e.g., management server 106). In one implementation, the mobile application is a Mobile Wallet application available from Mobile Candy Dish, Inc., of Alameda, Calif. In one implementation, the mobile application is a hosted service, as described in U.S. patent application Ser. No. 11/939,821, entitled "Method and System For Securing Transactions Made Through a Mobile Communication Device", which is incorporated herein by reference. In one implementation, the mobile application 200 is configured to send requests to the management server for artifacts based on user input, e.g., received through a keypad (not shown) of the mobile communication device 102. Requests to the management server 106 can also be automated, via proximity-based services, e.g., consumer tapping (or in close proximity) an LBS/contactless/RFID enabled phone against a smart poster (RFID/Bluetooth/LBS enabled, etc.), kiosk, or other device.

In one implementation, the mobile application 200 running on the mobile communication device 102 is configured to receive artifacts (e.g., advertisements, receipts, tickets, coupons, media, content, and so on) from the management server 106. In one implementation, the management server 106 sends artifacts to the mobile application based on user profile information and/or a transaction history (or payment trends) associated with a user of the mobile communication device 102 as described in U.S. patent application Ser. No. 11/944,267, entitled "Method and System For Delivering Information To a Mobile Communication Device Based On Consumer Transactions", which is incorporated herein by reference.

In one implementation, the mobile communication device 102 is an NFC-enabled phone. The mobile communication device 102 can be NFC-enabled, for example, through an embedded chip or a sticker that is affixed to the cellular phone, as described in U.S. application Ser. No. 11/933,321, entitled "Method and System For Adapting a Wireless Mobile Communication Device For Wireless Transactions", which is incorporated herein by reference. In one implementation, the NFC chip (or sticker) on the cellular phone can be used in conjunction with a merchant's point of sale device as described in greater detail below.

For example, with reference to FIG. 4, in one implementation, the NFC chip (or sticker) on the cellular phone can communicate with NFC chips that are installed on the front of PC's (TV's, Kiosks, or any other device) and serve as scanners/readers. In this implementation a mobile candy dish applet (e.g., MCD POS plugin 414) is installed on the consumer's computer (e.g., PC 404) which interfaces with the NFC chip on the PC. When a consumer (or user) is shopping online and they are ready to pay for their products, the consumer opens his mobile wallet and selects one of the payment methods (e.g., credit card, debit card, prepaid card, etc.) from their mobile wallet. If a default card has been selected already, this step is not necessary. The consumer then waves their phone over the NFC reader present on the PC 404. The consumer's payment credentials are transferred from the phone to the merchant website (e.g., online store application 410) using a communication protocol between the chip in the phone and the chip in the PC, which can be radio frequency for example. If the consumer has coupons in their mobile wallet the consumer can either elect to manually apply the coupon, save the coupon for a future use (against a larger purchase for example), or have the coupon automatically applied during the transaction and the transaction amount is

updated. After the consumer enters any necessary validation information (e.g., pin) to provide a multi-factor authentication and confirms the transaction, the online purchase is processed as normal by the merchant's online processor. The mobile wallet can retrieve transaction data, account balance from the management server **408**.

In one implementation, the mobile communication device **102** is a non NFC-enabled phone. In this implementation, the consumer connects his phone to the PC **404** via some non radio frequency method (e.g., IR, Bluetooth, USB cable, etc.). When a consumer is shopping online and they are ready to pay for their products, the consumer opens his mobile wallet and selects one of the payment methods (e.g., credit card, debit card, prepaid card, etc.) from their mobile wallet. If a default card has been selected already, this step is not necessary. The consumer then pushes, e.g., a "Buy now" button and the consumer's payment credentials are transferred from the phone to the merchant website (e.g., online store application **410**) using the protocol between the phone and the PC **404** which can be radio frequency, for example. If the consumer has coupons in their mobile wallet the consumer can either elect to manually apply the coupon, save the coupon for a future use, or have the coupon automatically applied during the transaction and the transaction amount is updated. After the consumer enters any necessary validation information (e.g., pin) to provide multi-factor authentication and confirms the transaction, the online purchase is processed as normal by the merchant's online processor. The mobile wallet can retrieve transaction data and account balance from the management server **408**.

In one implementation, the management server **408** and merchant portal (e.g., online store **408**) are maintained by trusted parties and use an encrypted tunnel to transfer financial data. When the consumer is ready to pay for their online product, they enter their cell phone number on the merchant portal. The merchant portal (which has an MCD applet (e.g., MCD POS plugin **414**) installed on its server) securely connects to the management server **408** (that in one implementation is maintained by Mobile Candy Dish (MCD)). In one implementation, the management server **408** identifies the consumer through their cell phone number, and verifies the consumer's authenticity by sending a unique transaction code to the consumer mobile wallet on their cell phone. The consumer then enters this unique transaction code onto the merchant's web portal. The merchant portal sends this transaction number to the management server **408** for authentication. Upon authentication, the consumer's virtual wallet and payment methods (e.g., credit card, debit card, prepaid card, etc.) are securely retrieved from the management server **408** and are displayed to the consumer in a window on a website associated with the merchant portal. The consumer selects one of these payment methods to pay for their transaction. If a default card has been selected already, this step is not necessary. If the consumer has coupons in their mobile wallet the consumer can either elect to manually apply the coupon, save the coupon for a future use, or have the coupon automatically applied during the transaction and the transaction amount is updated. After the consumer enters any necessary validation information to provide a multi-factor authentication and confirms the transaction, the online purchase is processed as normal by the merchant's online processor. The mobile wallet can retrieve transaction data, account balance from the management server **408**.

Referring to FIG. 2, in one implementation, the mobile application **200** maintains a shopping list **202** for a consumer. Accordingly, consumers have the ability to store their shopping list in their mobile wallet and add, delete, or change

items on their shopping list either in offline or online mode. In one implementation, consumers are sent coupons based on items on their shopping list, preferences, previous shopping history, proximity to the physical retail store, or a combination of these parameters, as discussed in application Ser. No. 11/944,267, which is incorporated by reference above. If the consumer has coupons in their mobile wallet the consumer can either elect to manually apply the coupon, save the coupon for a future use, or have the coupon automatically applied during the transaction and the transaction amount is updated. When a consumer wants to order the items on their shopping list via an online merchant (in contrast to a physical retail store), the consumer can logon to the merchant portal and electronically transmit their shopping list to the merchant portal either by waving their phone over NFC enabled PC's or some other connection such as IR, bluetooth, USB, or the like.

FIG. 3 illustrates a method **300** for conducting a payment transaction using a point of sale device (e.g., point of sale device **104**). User input is received selecting one or more items for purchase (e.g., at the point of sale device) (step **302**). In general, the transaction being made at the point of sale device can be any type of transaction that involves the exchange or transfer of funds—e.g., the transaction can be a payment transaction, a fund transfer, or other type of transaction. In response to a request from the user to purchase the one or more items, a total purchase amount for the one or more items is calculated (e.g., by the point of sale device) (step **304**). If the user has coupons in their mobile wallet the user can either manually apply the coupon or have the coupon automatically applied during the transaction and the transaction amount is updated. The user request to purchase an item can be received, e.g., by a user clicking on a "buy now" icon that is displayed on a graphical user interface of the point of sale device. Payment authorization for the total purchase amount is sent to a payment entity through a mobile communication device of the user (step **306**). A result of the payment authorization is received at the point of sale device from the payment entity via the mobile communication device (step **308**). The payment transaction is completed based on the result of the payment authorization (step **310**). If the payment transaction was authorized by the payment entity, then the sale of the items through the point of sale device is completed. Otherwise, if the payment transaction was not authorized by the payment entity, then the point of sale device terminates the payment transaction.

FIG. 4 illustrates an example payment transaction being made in a communication system **400** in accordance with one implementation. The communication system **400** includes a mobile communication device **402**, a personal computer (PC) **404**, an online store **406**, and a core (or datastore) **408**. As indicated by interaction (1), a user (or customer), using a phone (e.g., mobile communication device **402** or personal computer **404**), browses an online store website (online store application **410**) and finds an item that the customer wishes to purchase. This could also be a purchase made through a midlet application (POS midlet **412**) residing on the mobile communication device **402**. The user then goes to, e.g., a checkout of the online store **406** make a purchase. If the user has coupons in their mobile wallet the user can either manually apply the coupon or have the coupon automatically applied during the transaction and the transaction amount is updated. When it comes time to authorize the purchase, (in one implementation) the user is given an option to purchase with the mobile communication device **402**. In one implementation, the mobile communication device **402** is an NFC-equipped phone (or NFC phone).

In interaction (2), when the user chooses to purchase with the mobile communication device **402**, the online store application **410** sends the transaction information for authorization to the POS vendor plugin (e.g., MCD POS plugin **414**). In one implementation, the POS vendor plugin is installed in the merchant's online store and enables the merchant to accept MCD Blaze payments as an alternative form of payment, similar to accepting credit cards for payment. As shown by interaction (3), the POS vendor plugin formats, encrypts, and cryptographically signs the purchase authorization request which is sent via a secure SSL link (e.g., HTTPS, Bluetooth, IR, USB, or other suitable protocol) established by the browser/web application **416** back to the mobile communication device **402**. As with the first scenario, all communications is over secure channels. (It may be required that the mobile wallet application be opened prior to beginning a phone online purchase.) The POS midlet **412** is a component of the mobile wallet application that executes PayPass or other payment authorization protocol between itself and the SE payment applications on the mobile communication device **402** (interaction (4)). The results of the request are sent back to the POS vendor plugin.

As shown by interaction (5), the POS midlet **412** then forwards the properly formatted authorization request to a payment entity (e.g., issuer authorization **418**) for authorization. The results of the request are then sent back to the POS component of the mobile wallet. Through interaction (6), the POS midlet **412** then forwards the results back to the MCD POS plugin **414** to complete the purchase. The MCD POS plugin **414** then forwards the purchase transaction information to the management server **408** for later customer viewing (interaction (7)). As indicated by interaction (8), users (or customers) will then be able to query the management server **408** and immediately obtain purchase information, either by phone or PC.

One or more of method steps described above can be performed by one or more programmable processors executing a computer program to perform functions by operating on input data and generating output. Generally, the invention can take the form of an entirely hardware embodiment, an entirely software embodiment or an embodiment containing both hardware and software elements. In one implementation, the invention is implemented in software, which includes but is not limited to firmware, resident software, microcode, etc. Furthermore, the invention can take the form of a computer program product accessible from a computer-usable or computer-readable medium providing program code for use by or in connection with a computer or any instruction execution system. For the purposes of this description, a computer-usable or computer readable medium can be any apparatus that can contain, store, communicate, propagate, or transport the program for use by or in connection with the instruction execution system, apparatus, or device. The medium can be an electronic, magnetic, optical, electromagnetic, infrared, or semiconductor system (or apparatus or device) or a propagation medium. Examples of a computer-readable medium include a semiconductor or solid state memory, magnetic tape, a removable computer diskette, a random access memory (RAM), a read-only memory (ROM), a rigid magnetic disk and an optical disk. Current examples of optical disks include compact disk-read only memory (CD-ROM), compact disk-read/write (CD-R/W) and DVD.

FIG. 5 illustrates a data processing system **500** suitable for storing and/or executing program code. Data processing system **500** includes a processor **502** coupled to memory elements **504A-B** through a system bus **506**. In other implementations, data processing system **500** may include more than

one processor and each processor may be coupled directly or indirectly to one or more memory elements through a system bus. Memory elements **504A-B** can include local memory employed during actual execution of the program code, bulk storage, and cache memories that provide temporary storage of at least some program code in order to reduce the number of times the code must be retrieved from bulk storage during execution. As shown, input/output or I/O devices **508A-B** (including, but not limited to, keyboards, displays, pointing devices, etc.) are coupled to data processing system **500**. I/O devices **508A-B** may be coupled to data processing system **500** directly or indirectly through intervening I/O controllers (not shown).

In one implementation, a network adapter **510** is coupled to data processing system **500** to enable data processing system **500** to become coupled to other data processing systems or remote printers or storage devices through communication link **512**. Communication link **512** can be a private or public network. Modems, cable modems, and Ethernet cards are just a few of the currently available types of network adapters.

The wireless mobile devices also include a near field communication (NFC) device, coupled with some type of transaction device having a code, such as a smart card that uses an RFID for identification purposes, allow for debit cards to securely make a simple transaction, such as purchasing a bus ticket, by simply waving the wireless mobile device near a reader installed on the bus, so that the bus fare is deducted from a total amount that is available stored on the smart card of the wireless mobile device, or by forwarding the fare to a server that can identify the identification code of the particular RFID and then subsequently charge the user. The system and method allow the user to complete a transaction using a wireless mobile communication channel and another communication channel, particularly another communication channel that provides for near field radio channels (NFC), as well as other communication channels, such as Bluetooth or WIFI. The system may have a hand-held mobile device that wirelessly communicates between a secure element and a radio element that are associated with the hand-held mobile device. The system also has a hand-held mobile device that has a secure element that is insertable into a body of the hand-held mobile device, to thereby allow for wired communication between the secure element and a radio element of the hand-held mobile device.

FIG. 6 illustrates another implementation of the communication system including a wireless mobile communication device and a management server in accordance with one implementation. One feature of the system **100** is the hand-held mobile device **110**. The mobile device **100** includes a radio element **120** and a secure element **130**. A display **124** is shown associated with the radio element **120**, and antennas, not labeled, are shown as associated with each of the radio element **120** and the secure element **130**, although it is noted that the illustration of antenna can physically be implemented in a manner that is different from the wireless antenna shown, such as by a stripe is passed along a reader, or some other transmission mechanism. Although elements **120** and **130** are shown as distinct and separate, and display **124** is shown as connected to the radio element **120**, it will be understood that other configurations are within the scope of the invention, in particular, a combination in which a single processor is used to execute the functions that are currently performed and described herein as being provided by both the radio element **120** and the secure element **130**, as described further herein. Further as illustrated in FIG. 6. Both the radio element **120** and the secure element **130** are internal to the mobile device **110** as illustrated, although in certain embodiments the secure

element **130** can be external to the mobile device **110**, as described hereinafter. Also, various different functionalities can be included within the radio element **120** and the secure element **130**, as also described hereinafter.

The point-of-sale terminal **150** receives one of the transaction request signals from the mobile device **110** and transmits the one transaction request signal to the transaction server **170**, typically using a communication channel **160** such as the internet. The transaction server **170** that receives the one transaction request signal from the point-of-sale terminal **150** verifies the transaction, and forwards a transaction verification signal to the management server **180**. The management server **180** that receives the transaction verification signal, identifies the user corresponding thereto, and provides as one of the transaction signals, a first transaction response signal back to the mobile device **110**.

In one implementation, application programs running on the radio processor **123** are, e.g., BREW or J2ME applications and can encompass a broad array of application types. For example, current applications include games, enterprise applications, and multimedia applications. In one implementation, the radio processor **123** runs an application that provides movie and event information. Such an application can comprise ticketing applications, content, item and service purchase applications, and/or payment management applications (referred to herein also as “wallet applications”). In one implementation, the radio processor **123** also has the capability of recognizing secure communications, and transmits data which must be stored in a secure environment to the secure element driver **128** for transmission to the secure element **130**. In one implementation, in which both the radio element **120** and the secure element **130** are internal to the mobile communication device **110**, transmissions to the secure element **130** can take place using an internal wired communication channel. In one implementation, the radio processor **123** also has the capability of receiving data from the secure element **130**, e.g., using the internal wired communication channel. In one implementation, the secure element **130** and the radio element **120** communicate using signals described in the Java Card 2.1 Platform API Specification.

In one implementation, both the radio element **120** and the secure element **130** are disposed internally within a body of the mobile communication device **110**. For example, referring to FIG. **8**, the mobile communication device **110** is shown including a slot **400**, which allows for the insertion of a secure element **130** into the slot **400**. In this configuration, the secure element **130** can be purchased independently of the mobile communication device **110**. The secure element **130** can also be disposed into a slot that only provides for physical insertion and mechanical connection to the body of the mobile communication device **110**. In such an implementation, the secure element can include a transceiver that allows for the communication with the radio element **130** through a wireless local communication channel. The radio element **120** also is illustrated as optionally including another transceiver **129**, such as a Bluetooth or WIFI transceiver, which can transmit and receive signals with an external device and then communicate signals to and from the radio processor **123**. This additional communication channel allows for communications between other external devices, such as an external Bluetooth enabled smartcard, and provides an additional communication channel that is useful for certain transactions, as described further herein.

FIG. **9A** illustrates one implementation of the secure element **130** associated with the mobile communication device **110**. The secure element **130** can be a smart card. In one implementation, the secure element **130** includes a secure

processor **132**, a secure memory **133**, and a POS transceiver **134** adapted to send transaction request signals and receive transaction response signals over a first communication channel. In one implementation, the secure processor **132** communicates via the secure element driver **128** with the radio processor **123** using signals as described in the Java Card 2.1 Platform API Specification. The transaction request signals and the transaction response signals associated with the transaction can include an identification code associated with the user, as well as information relative to the transaction, such as item, quantity, vendor, and so on. In one implementation, the POS transceiver **134** is an NFC device, which uses an NFC modem. The POS transceiver **134** can also be a Bluetooth, WIFI or other transceiver. In an implementation in which the POS transceiver is an NFC modem, such an NFC modem will typically have a set of registers that can be read/written by the secure processor **132**. These registers are in turn available for reading and writing over the RFID communications channel and serve as a shared memory between the secure processor **123** within the secure element **130** and the RFID reader that is associated with the POS terminal **150**. This communication is specified, for example, in the ISO 14443A/B standard. The secure element can optionally include a radio/Bluetooth/WIFI transceiver **136**, which can communicate with other devices, such as a transceiver associated with the radio processor **120** or for other external devices having those communication capabilities, thus allowing for more flexibility.

FIG. **9B** shows another implementation of a secure element **130**, in which the radio element **120** does not communicate with the secure element **130** through a secure element driver **128**. In this case, for example, the secure element **130** may be external to the mobile communication device **110** and as such is not connected to the radio element through the secure element driver **128**. In such an implementation, however, if the transceiver **136** as described above is included, and a similar transceiver **129** associated with the radio element **130** as described previously with respect to FIG. **7** is included, then this communication channel can be used to wirelessly obtain direct communications between the radio element **120** and the secure element **130**. This implementation allows for certain bidirectional communications with other devices, as well as with the radio element **120**, and as such more functionality and flexibility is achieved. This implementation is particularly useful since it establishes a direct local communication path with the radio element **120**, since there is not communications with the radio element **120** via the path of driver **128**.

FIG. **12** illustrates one implementation of a secure element **130** that can be attached (or affixed) externally to a wireless communication device (e.g., mobile communication device **110**). In one implementation, the secure element **130** has circular shape. The secure element **130** can have other suitable shapes—e.g., rectangular, triangular, and so on. In one implementation, the secure element **130** includes an embedded smart chip **702** that is capable of executing proximity services (e.g., services related to payments, ticketing, identification, sending coupons, etc.). In one implementation, the smart chip **702** is capable of 2-way wireless communication (e.g., RFID, NFC, Bluetooth, etc.) with a supporting 3rdParty terminal. In one implementation, the 2-way communication is performed using a communication protocol that is different from a communication protocol through which the mobile communication device sends or receives voice and/or data signals. Multiple application protocols (NFC, MiFare, etc.) can be supported. In one implementation, the smart chip **702** is programmable. Accordingly, different application (for payments, ticketing, identification, coupons, etc.) can be devel-

oped, downloaded to the smart chip, and commissioned. Thus in operation, in response to the secure element **130** being placed in close proximity with a suitable terminal, the terminal will trigger (via application protocol) an appropriate application stored in the smart chip, and the smart chip will respond appropriately with the terminal.

In one implementation, the mobile application **910** provides banking and money management service, which includes (but is not limited to):

Registration: User creates new MW Lite account with PIN (PIN and user info can be stored in user/profile database **306**)

Security & Encryption: Sensitive information may optionally be encrypted using 3rdParty or native phone tools (Bouncy Castle, etc.). Encryption (Public/Private) keys may be managed or proxy'd by Server which may additionally be out-sourced to 3rdparty Key Management vendor.

Install & Configuration (I&C): Refers to setting up proxies to

payment accounts (virtual, credit, debit & banking) Payees (BillPay, PayAnyone, etc.) and associated rules Specify default payment account to debit fund transfers/unloading

Specify default payment account to credit fund transfers/loading

Activation of 3rdParty Services (Account Balance, Bill Pay, Fund Transfer, Funds Loading, Funds Unloading)

It is assumed Client application is pre-installed or downloaded to mobile device.

I&C to be performed via Kiosk, ATM, 3rdParty/Carrier Web Portal, MCD Web Portal, on mobile device, or other suitable device.

Loading Funds

Banking or financial data

Account balance

Transaction history

Bill Pay—Biller Direct

Fund Transfer—Intra Bank; Me-2-Me

Fund Transfer—Inter Bank; Me-2-Me

Fund Transfer—Inter Bank; Me-2-You (based on Bank Routing/Account#)

Fund Transfer—Inter Bank; Me-2-You (based on WalletID)

Fund Transfer—Inter Bank; Me-2-You (based on ACH Check). A.k.a. Bill Pay Anyone

Load Fund

Unload Funds (ATM Withdrawal, etc.)

Sync: Ensures server-side objects are downloaded to client and locally cached. This includes payment accounts, payees, payment rules, server-side cached account info (account balance, Last-N transaction history), etc. This info will be cached on Client.

Users can create transaction either in ONLINE or OFFLINE (no network connectivity) mode

Initiating/Triggering Banking Services:

Storage: Storage of Users MWLite info, User's payment account info (credentials, account balance, history, etc.); Banking Payment History (BillPay, Fund Transfer, Fund Loads, Fund Unloads, etc.) Scenarios/Features

In one implementation, a mobile communication device creates task/objects either while connected with a Server (online-mode) or when no connection is available (offline-mode). Tasks/objects are specific to mobile banking service and include for example: schedule (or cancel) a fund transfer transaction, schedule (or cancel) a bill pay transaction, and

manage other banking transactions. In addition, digital artifacts (coupons, tickets, etc.) that possess a state (or status) (e.g., Assigned, Saves, Redeemed, Deleted, etc.) can undergo changes on the mobile communication device. Given these tasks/objects associated to Banking Services and Digital Artifacts has 'states' that can be changed in either an online-mode or offline-mode, the Server has to be refreshed/updated either in real-time (online-mode) or in batch (offline-mode).

Using the client (or mobile application), a user can store digital artifacts (e.g., coupons, tickets, etc.) on a mobile communication device. These digital artifacts are objects that are consumed by a 3rdParty, e.g., a ticket can be redeemed at a theater, and a coupon can be redeemed at the Point-Of-Sale of a retail merchant. Hence, this is a 3-way sync: 1) mobile communication device with server, 2. mobile communication device with 3rdParty Merchant, and 3) server with 3rdParty Merchant. For user's convenience, redemption of digital artifacts by a 3rdParty must be enabled in an environment with or without network access. For example, a user with an electronic ticket on a mobile communication device may wish to redeem an eTicket at a theater. However, if there is no network access inside the theater, the user will still need access the eTicket on the client. In ONLINE mode, the client will cache (local store) the eTicket (and any other digital artifact.) In the theater, the client (in OFFLINE mode) will be able to redeem the eTicket and update the state of the eTicket on the mobile communication device (e.g., change state from 'valid' to 'redeemed'). This prevents the user from re-using the eTicket. At some point when the mobile communication device re-acquires network connectivity, the client will then negotiate with the server and any artifacts with a state change (e.g., 'valid' to 'redeemed', etc.) on the client are then uploaded to the server (e.g., either in batch mode or one task at a time).

The point of sale terminal **150** illustrated in FIG. **10** is conventional, in that it has the capability of electronically reading information from a device equipped to transmit information in a format that it reads. Thus, the reader **152** within the point of sale terminal **150** can be of one or many types. If the point of sale terminal reader **152** includes the provision for NFC communications, then simply bringing the secure element **130** with the NFC transceiver will cause initiation of a transaction and the transmission of the identification code associated with the secure element **130** and thus the user.

FIGS. **11A-11D** illustrate a flowchart of a transaction in accordance with one implementation, and the various steps that are included in the transaction, with reference to which of the various devices are implementing this step. Referring to FIG. **11A**, a user first waves a mobile communication device **530** (e.g., a NFC device or device having an attached sticker) across (or near) a POS terminal **540**. The POS terminal **540** identifies the technology associated with the mobile communication device, a payment method, user credentials, and payment credentials. Irrespective if t mobile communication device is a NFC-Phone or includes an attached sticker, the mobile communication device sends to the POS Terminal **540** payment credentials including optional credentials (e.g., WalletID). As shown in FIG. **6B**, using optional credentials (e.g., WalletID), contact is made with a transaction server **510** to request payment credentials. The POS terminal **540** determines if a security code prompt (e.g., a PIN) is needed? If yes, a prompt is made for the security code (PIN) on the POS terminal **540** and the process continues with processing of the payment. Otherwise, the POS terminal **540** simply proceeds with processing of the payment. As an alternative, the POS terminal **540** can integrate via the back office to a management server **510** and trigger a PIN prompt on the mobile communication device. In such a case, the user can enter the

PIN on the mobile communication device (instead of through the POS terminal 540). The POS terminal 540 hands processing to a payment broker.

Referring to FIG. 11C, assuming the POS terminal 540 was capable of 2-way communication, if the POS terminal 540 determines that the mobile communication device is a NFC Phone, the POS terminal 540 can write digital artifacts (e.g., eReceipts, eTickets, eCoupons, etc.) to the mobile communication device. Non-secure data is stored in the mobile communication device. Otherwise, the POS terminal 540 sends optional digital artifacts to the management server 510. As part of an out-of-band sync between the management server 510 and the mobile communication device, the non-secure digital artifacts are downloaded and stored in the mobile communication device. Secure digital artifacts are downloaded to the mobile communication device and stored on a secure element of the mobile communication device (if possible).

The two transaction workflows that have been specifically discussed above are the credit card and ticketing workflows. Other transaction flows can also be implemented. Debit card and cash card transactions are similar to credit card transactions, with variations being implemented to account for the differences that exist in those types of transactions, which types of transactions are well understood. Coupons can be implemented with the invention, in much the same manner as tickets, though coupons can be transmitted without there being payment. Many of the transaction types noted herein will, as is apparent, require communication between the secure element 130 and the radio element 120. As such, due to that requirement, a significant part of the preceding discussion has been directed to how to implement that communication, particularly for mobile communication devices 110 that are not manufactured to allow for such communications.

An example of a typical transaction requiring such communication between the secure element 130 and the radio element 120 is one in which the POS terminal 150 allows for the transfer of detailed purchase information from the POS terminal 150 to the secure element 130, as well as transactional information from the POS terminal 150 and/or the transaction server 170 to the management server 180. The management server 180 can then also communicate with the radio element 120 via the radio channel. This allows for the matching and reconciliation of detailed purchase information and, if the transaction fails, failure details can be matched to the purchase information, and forwarded in real-time to the user via the radio element 120. In one implementation, there is included the provision for different phones to communicate the results of a transaction, particularly using the POS transceiver or one of the Bluetooth/Wifi transceivers. In this implementation, after a transaction has been completed with one of the mobile communication devices 110a, another mobile communication device 110b can receive information regarding the transaction completed. Thus, for instance, if mobile communication device 110a purchases two tickets, one of the tickets can be transmitted to the mobile communication device 110b by each using a POS transceiver or one of the Bluetooth/Wifi transceivers.

FIG. 16 illustrates a block diagram of a communication system including a wireless mobile communication device and a management server in accordance with one implementation.

FIG. 13 illustrates one implementation of the management server 106. As shown in FIG. 13, the management server 106 includes a correlation engine 300, a user profile database 302, and an artifacts database 304. The correlation engine 300 can correlate user profile information (e.g., location, gender, age,

interest, affiliations, etc.) stored in the user profile database 302 with other data (historical payment transactions, real-time payment transactions, etc.) stored in the artifacts database 304, and/or location of a user to provide more relevant targeting parameters for which to target, identify and distribute relevant artifacts to a user. In one implementation, the management server 106 is a server that is maintained by Mobile Candy Dish, Inc.

In one implementation, the user profile database 302 is continually updated with information pertaining to the user—e.g., location, payment history, transaction history, and the like. In addition, the artifacts database 304 can be continually updated with new artifacts that can be sent to users—e.g., users that are subscribed to, e.g., the Mobile Wallet application. For example, metadata can be associated to artifacts stored in the artifacts database 304. The metadata can be leveraged to trigger a secondary call-to-action, e.g., to encourage user behavior. For example, it may be desired for a user to enter an email address, accept coupon/rewards, opt-in for alerts and notification, etc. When an artifact is sent to a user, the metadata associated with the artifact can provide the additional dynamic next steps (e.g., through a user interface screen) to provoke the desired user action.

FIG. 14 illustrates one example of the user profile database 302 including user profiles for USER 1 and USER 2. As discussed above, in one implementation, the user profile database is continually updated based on transactions of a user. Accordingly, the user profile database 302 includes a plurality of targeting parameter fields—e.g., targeting parameter fields 1-4—that define targeting parameters that have been satisfied by (or apply to) a user. That is, USER 1 satisfies targeting parameters 1 and 4, while USER 2 satisfies targeting parameters 1, 2, and 4. In general, the user profile database 302 includes other fields (not shown) for storing other attributes associated with users—e.g., personal information. The artifacts database 304 can similarly include targeting parameters that correspond to each artifact. And in one implementation, the correlation engine 300 (FIG. 3) performs correlations between user-data targeting parameters and content targeting parameters in order to match relevant artifacts/content to a specific user profile based on various content distribution rules.

FIG. 15 illustrates one implementation of a method 600 for sending an artifact to a mobile communication device of a user. A request to send an artifact to a user is received (e.g., by correlation engine 300) (step 306). The request can be a request generated from a user or be an automated request generated from a point-of-sale device, kiosk, or other device. In general, the artifact can be an advertisements, receipt, ticket, coupon, media, content, and so on. User target parameters from a user profile of the user are retrieved (e.g., by correlation engine 300) (step 604). A transaction history of the user is retrieved (e.g., by correlation engine 300) (step 606). An artifact is sent (from the management server) to the user based on the user target parameters and the transaction history of the user (step 608).

FIG. 16 illustrates one implementation of a communication system 900. The communication system 900 includes computing devices and a management server (designated “server”). The management server includes a correlation engine, a query manager, a user profile manager, and an inventory controller. The management controller is in communication with a user profile database, a payment transaction history database, and an artifact inventory database. The management server is also in communication with a bank so that raw data may be downloaded from banks and stored in local storage. In one implementation, data-mining and report-

ing tools are leveraged by the management server to define aggregated reports. Additionally, aggregated data may be downloaded from banks that provide/support data-mining and ad-hoc reporting tools.

In operation, a user opens an application (e.g., a web-browser) on a computing device (a mobile communication device). The application queries the management Server for an artifact, providing pageId (scene identifier) and userId, where the pageId can represent a specific screen, scene or real-estate property. The query can be initiated/triggered via following mechanisms, but not limited to: Browsing a particular screen/web-page that specify unique real-estate; leveraging proximity services (NFC/Contactless, etc.) that specify unique code or identifier; geographic location (LBS, Bluetooth, etc.). The management server collects targeting Meta Data based on the user's userId. The management server leverages multiple data sources including, but not limited to: user profiles (e.g., for location, gender, age, interest, affiliations, etc.); payment transactions (e.g., for top 5 spend categories, upcoming bill pay transactions, merchants, etc.). Leveraging payment transactions and banking transactions provides a good future trending of a user's behavior, including a level of importance/relevancy. Mining this data (for spend category, merchant, price level, etc.) provides a rich set of attributes that better describes a user's retail preference. The management server queries the artifact inventory against query parameters based on targeting meta data. If multiple matches are determine, the correlation engine uses predetermined business rules and identifies and returns a URL (Universal Resource Locator) to a unique artifact. The user (or consumer) can use the application running on the mobile communication device to retrieve artifact/content based on the provided URL.

In general, while effort is made to minimize storage of sensitive user information and data in a memory of a mobile communication device, in one implementation, some data is stored in the memory of a mobile communication device due to reasons of performance, usability and user experience. For example, data may need to be stored on a mobile communication device in the following circumstances. Payment credentials, coupons, tickets, and so on may have to be stored on the secure element of an NFC phone. Account balance, banking payment history, etc., may be locally cached on a mobile communication device. In one implementation, a user can opt-in to save payment method security codes in the client (or mobile application) for convenience. Tickets and/or coupons may be locally cached so that a user can redeem the tickets and/or coupons in an offline mode. For example, a mobile communication device may be offline in a situation in which network connectivity inside a building is degraded, and storing a ticket and/or coupon in a local cache of the mobile communication device permits the user to access the ticket or coupon.

In one implementation, while a client is open, a user has access to transaction data. In such an implementation, users who may misplace a mobile communication device while the client is open may expose the user to risk of information theft. Therefore, in one implementation, mobile application (or client) shuts down after a period of inactivity. Additional tasks that can be associated with the shutdown procedure can include, but is not limited to, temporarily shutting down a secure element (of the mobile communication device) to prevent NFC payments, NFC coupon redemption, and NFC ticket redemption.

Rewards/Loyalty/Coupons—A user can keep track of reward/loyalty cards—e.g., frequently flyer account number, rental car reward membership, hotel reward membership, and

the like—through the rewards module. In one implementation, a user can view, in real-time, a summary of all rewards (e.g., points accumulated) directly on a cellular phone. A user can also search for and store coupons on their mobile communication device for use during, e.g., a contactless purchase.

Although the present invention has been particularly described with reference to implementations discussed above, various changes, modifications and substitutes are can be made. Accordingly, it will be appreciated that in numerous instances some features of the invention can be employed without a corresponding use of other features. Further, variations can be made in the number and arrangement of components illustrated in the figures discussed above.

While the foregoing has been with reference to a particular embodiment of the invention, it will be appreciated by those skilled in the art that changes in this embodiment may be made without departing from the principles and spirit of the disclosure, the scope of which is defined by the appended claims.

What is claimed is:

1. A method comprising:

maintaining a mobile application in a mobile device memory included in a mobile device, the mobile device including a mobile device display, a mobile device radio transceiver, and a mobile device processor, and wherein a secure element is coupled to the mobile device;

executing the mobile application using the mobile device processor, wherein execution of the mobile application permits a user of the mobile device to conduct a near field communication (NFC) transaction with a point-of-sale terminal;

initiating execution of a near field communication application operating at an application layer above a physical layer by a secure element processor in response to a near field communication interaction triggered from the point-of-sale terminal to the secure element without communication with the mobile device, the near field communication application stored in a secure element memory of the secure element;

automatically applying a coupon during processing of the near field communication transaction and sending transaction data including payment credentials corresponding to a default payment mechanism in association with execution of the near field communication application from the secure element to the point-of-sale terminal without prior authentication.

2. The method of claim 1, wherein a digital artifact is delivered from a management server to the mobile device through the mobile device radio transceiver, wherein the digital artifact includes metadata operable to trigger a call-to-action.

3. The method of claim 2, wherein the digital artifact comprises an advertisement, receipt, ticket, media, metadata and/or content.

4. The method of claim 2, wherein the call-to-action is a user prompt to enter an email address, accept a coupon/reward, and/or opt-in for alerts and notifications.

5. The method of claim 2, wherein the digital artifact is sent to the mobile device based on targeting parameters associated with personal information and transaction history stored at the management server.

6. The method of claim 5, wherein personal information includes user location, gender, age, interest, and/or affiliations and wherein transaction history comprises historical payment transactions, real-time payment transactions, banking transactions, bill pay, merchants, price-level, spend cat-

17

egories, transactions conducted through the mobile device, and/or transactions downloaded from banks.

7. The method of claim 2, wherein the digital artifact is sent to the mobile device when a user of the mobile device browses a particular screen of the mobile device application that specifies unique real-estate, uses proximity services such as near field communications that specify a unique code, or accesses location-based services.

8. The method of claim 1, wherein a shopping list is transmitted from the mobile device to the point-of-sale terminal prior to initiating the near field communication interaction.

9. The method of claim 2, wherein the digital artifact is sent to the mobile device based on movement of the mobile device into close proximity of a smart poster, a radio frequency identification (RFID) device, a Bluetooth device, or a location-based service device.

10. The method of claim 2, wherein the digital artifact is received through a near field communication transceiver at the secure element after purchase from the point-of-sale terminal, wherein the digital artifact comprises a receipt, coupon, ticket, and/or return/refund policy.

11. The method of claim 1, wherein transaction data is transmitted from the mobile device to another mobile device using near field communications, Bluetooth, and/or wireless fidelity (WiFi).

12. The method of claim 1, wherein the secure element is physically coupled to the mobile device but electrically decoupled from the mobile device.

13. The method of claim 12, wherein the secure element is included in a housing associated with the mobile device.

14. The method of claim 1, wherein a security tool is implemented at the mobile device application, the security tool configured to prompt a user to login to the mobile device, use biometrics to authenticate the user before authorizing a transaction, prompt the user to enter a payment limit PIN in response to a pending purchase exceeding a pre-determined amount, temporarily disable the secure element, permanently disable the secure element, delete all cached data stored in mobile device memory, and/or store encrypted security codes on the mobile device, wherein disabling the secure element prevents near field communication payments, coupon redemption and ticket redemption.

15. The method of claim 2, wherein a status of the digital artifact is received at the mobile device, wherein the status is one of assigned, saved, redeemed or deleted.

18

16. The method of claim 1, wherein data is exchanged between the secure element processor and the mobile device processor.

17. The method of claim 1, wherein the secure element comprises a ticketing application, an identity application and/or a coupon application.

18. A mobile device comprising:

a mobile device memory configured to maintain a mobile application;

a mobile device display;

a mobile device radio transceiver; and

a mobile device processor configured to execute the mobile application, wherein execution of the mobile application permits a user of the mobile device to conduct a near field communication (NFC) transaction with a point-of-sale terminal,

wherein a secure element is coupled to the mobile device, the secure element comprising:

a secure element memory configured to maintain a near field communication application; and

a secure element processor configured to initiate execution of the near field communication application operating at an application layer above a physical layer in response to a near field communication interaction triggered from the point of sale terminal to the secure element, the execution of the near field communication application automatically applying a coupon during processing of the near field communication transaction and sending transaction data including payment credentials corresponding to a default payment mechanism from the secure element to the point-of-sale terminal without prior authentication and communication with the mobile device.

19. The mobile device of claim 18, wherein a digital artifact is delivered from a management server to the mobile device through the mobile device radio transceiver, wherein the digital artifact includes metadata operable to trigger a call-to-action.

20. The mobile device of claim 19, wherein the digital artifact comprises an advertisement, receipt, ticket, media, metadata and/or content.

* * * * *