



US008693995B2

(12) **United States Patent**
Fisher

(10) **Patent No.:** **US 8,693,995 B2**
(45) **Date of Patent:** **Apr. 8, 2014**

(54) **CUSTOMIZED MOBILE APPLICATIONS FOR SPECIAL INTEREST GROUPS**

(75) Inventor: **Michelle Fisher**, Oakland, CA (US)

(73) Assignee: **Michelle Fisher**, Oakland, CA (US)

(*) Notice: Subject to any disclaimer, the term of this patent is extended or adjusted under 35 U.S.C. 154(b) by 1434 days.

(21) Appl. No.: **11/956,261**

(22) Filed: **Dec. 13, 2007**

(65) **Prior Publication Data**

US 2009/0156190 A1 Jun. 18, 2009

(51) **Int. Cl.**
H04M 3/00 (2006.01)

(52) **U.S. Cl.**
USPC **455/418**; 370/338

(58) **Field of Classification Search**
USPC 455/418; 348/14.01–14.07; 705/14.57, 705/14.58, 14.62, 14.63
See application file for complete search history.

(56) **References Cited**

U.S. PATENT DOCUMENTS

6,038,367 A	3/2000	Abecassis	
6,101,483 A	8/2000	Petrovich et al.	
6,115,601 A	9/2000	Ferreira	
6,123,259 A	9/2000	Ogasawara	
6,128,655 A	10/2000	Fields et al.	
6,141,666 A	10/2000	Tobin	
6,199,082 B1	3/2001	Ferrel et al.	
6,250,557 B1	6/2001	Forslund et al.	
6,415,156 B1	7/2002	Stadelmann	455/466
6,450,407 B1	9/2002	Freeman et al.	
6,587,835 B1	7/2003	Treyz et al.	
6,605,120 B1	8/2003	Fields et al.	
6,771,981 B1	8/2004	Zalewski et al.	455/557

6,772,396 B1	8/2004	Cronin et al.	
6,886,017 B1	4/2005	Jackson et al.	707/104
6,950,939 B2	9/2005	Tobin	713/182
7,031,945 B1	4/2006	Donner	705/64
7,069,248 B2	6/2006	Huber	705/64
7,096,003 B2	8/2006	Joao et al.	455/406
7,110,744 B2	9/2006	Freeny, Jr.	455/406
7,110,792 B2	9/2006	Rosenberg	
7,127,236 B2	10/2006	Khan et al.	455/414.1
7,188,089 B2	3/2007	Goldthwaite et al.	
7,200,578 B2	4/2007	Paltenghe et al.	
7,289,810 B2	10/2007	Jagadeesan et al.	455/439
7,308,254 B1	12/2007	Rissanen	455/414.1
7,357,312 B2	4/2008	Gangi	235/380
7,379,920 B2	5/2008	Leung et al.	705/67
7,472,829 B2	1/2009	Brown	235/382.5
7,482,925 B2	1/2009	Hammad et al.	340/572.1
7,512,567 B2	3/2009	Bemmel et al.	

(Continued)

FOREIGN PATENT DOCUMENTS

WO WO 2006095212 9/2006

OTHER PUBLICATIONS

Office Action for U.S. Appl. No. 11/933,351 dated Oct. 3, 2008.
Office Action for U.S. Appl. No. 11/948,903 dated Feb. 2, 2009.

(Continued)

Primary Examiner — Marcos Batista

(57) **ABSTRACT**

A method and system for customizing a mobile application running on a mobile communication device of a user. In one implementation, the method includes providing the mobile application to the mobile communication device of the user, the mobile application having a generic platform; determining a special interest group (SIG) that is affiliated with the user; and customizing the generic platform of the mobile application based on information specific to the special interest group (SIG) that is affiliated with the user.

27 Claims, 10 Drawing Sheets

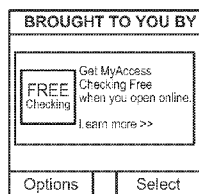

Landing Screen

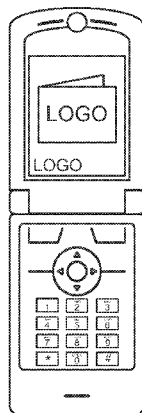

Messages

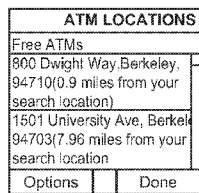
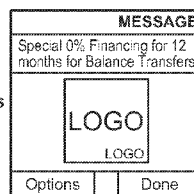

ATM Locations

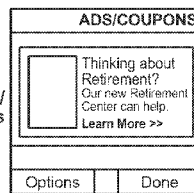

Ads/Coupons

(56)

References Cited

U.S. PATENT DOCUMENTS

7,522,905 B2 4/2009 Hammad et al. 455/410
 7,784,684 B2 8/2010 Labrou et al.
 7,870,077 B2 1/2011 Woo et al.
 7,979,519 B2 7/2011 Shigeta et al.
 8,005,426 B2 8/2011 Huomo et al.
 8,019,362 B2 9/2011 Sweatman et al.
 8,073,424 B2 12/2011 Sun et al.
 8,086,534 B2 12/2011 Powell
 8,109,444 B2 2/2012 Jain
 8,127,984 B2 3/2012 Zatloukal et al.
 2001/0011250 A1 8/2001 Paltenghe et al.
 2001/0044751 A1 11/2001 Pugliese et al.
 2002/0065774 A1 5/2002 Young et al.
 2002/0077918 A1 6/2002 Lerner et al. 705/26
 2002/0082879 A1 6/2002 Miller et al. 705/5
 2002/0107756 A1 8/2002 Hammons et al. 705/26
 2002/0151294 A1* 10/2002 Kirby et al. 455/406
 2002/0160761 A1 10/2002 Wolfe
 2002/0169984 A1 11/2002 Kumar et al. 713/201
 2003/0061113 A1 3/2003 Petrovich et al.
 2003/0065805 A1 4/2003 Barnes, Jr. 709/231
 2003/0074259 A1 4/2003 Slyman et al.
 2003/0085286 A1 5/2003 Kelley et al.
 2003/0087601 A1 5/2003 Agam et al.
 2003/0093695 A1 5/2003 Dutta 713/201
 2003/0105641 A1 6/2003 Lewis 705/1
 2003/0132298 A1 7/2003 Swartz et al.
 2003/0163359 A1 8/2003 Kanesaka
 2003/0172028 A1 9/2003 Abell et al. 705/40
 2004/0006497 A1 1/2004 Nestor et al. 705/5
 2004/0030658 A1 2/2004 Cruz 705/65
 2004/0073497 A1 4/2004 Hayes et al.
 2004/0127256 A1 7/2004 Goldthwaite et al.
 2004/0235450 A1 11/2004 Rosenberg
 2004/0243519 A1 12/2004 Perttila et al. 705/75
 2004/0254836 A1 12/2004 Emoke Barabas et al.
 2004/0267618 A1 12/2004 Judicibus et al. 705/16
 2005/0040230 A1 2/2005 Swartz et al.
 2005/0076210 A1 4/2005 Thomas et al. 713/165
 2005/0187873 A1 8/2005 Labrou et al.
 2005/0215231 A1 9/2005 Bauchot et al. 455/405
 2006/0031752 A1 2/2006 Surloff et al.
 2006/0089160 A1* 4/2006 Othmer 455/457
 2006/0089874 A1 4/2006 Newman et al.
 2006/0091200 A1* 5/2006 Lai et al. 235/380
 2006/0143091 A1 6/2006 Yuan et al.
 2006/0178130 A1* 8/2006 Makrygiannis 455/406
 2006/0191995 A1 8/2006 Stewart et al.
 2006/0206709 A1 9/2006 Labrou et al.
 2006/0219780 A1 10/2006 Swartz et al.
 2007/0011099 A1 1/2007 Sheehan
 2007/0022058 A1 1/2007 Labrou et al.
 2007/0067329 A1* 3/2007 Kamvar et al. 707/102
 2007/0095892 A1 5/2007 Lyons et al. 235/379
 2007/0125838 A1 6/2007 Law et al.
 2007/0125840 A1 6/2007 Law et al.
 2007/0138299 A1 6/2007 Mitra

2007/0156436 A1 7/2007 Fisher et al.
 2007/0185768 A1* 8/2007 Vengroff et al. 705/14
 2007/0210155 A1 9/2007 Swartz et al.
 2007/0255662 A1 11/2007 Tumminaro 705/79
 2007/0270166 A1 11/2007 Hampel et al.
 2007/0293155 A1 12/2007 Liao et al.
 2008/0010196 A1 1/2008 Rackley, III et al.
 2008/0017704 A1 1/2008 VanDeburg et al.
 2008/0045172 A1 2/2008 Narayanaswami et al.
 2008/0048022 A1 2/2008 Vawter
 2008/0051059 A1 2/2008 Fisher
 2008/0051142 A1 2/2008 Calvet et al.
 2008/0052192 A1 2/2008 Fisher
 2008/0052233 A1 2/2008 Fisher et al.
 2008/0139155 A1 6/2008 Boireau et al. 455/296
 2008/0167988 A1 7/2008 Sun et al.
 2008/0177668 A1 7/2008 Delean 705/76
 2008/0208681 A1 8/2008 Hammad et al. 705/13
 2008/0208743 A1 8/2008 Arthur et al.
 2008/0208744 A1 8/2008 Arthur et al.
 2008/0208762 A1 8/2008 Arthur et al.
 2008/0221997 A1 9/2008 Wolfe
 2008/0255947 A1 10/2008 Friedman
 2008/0275779 A1 11/2008 Lakshminarayanan
 2008/0281694 A1* 11/2008 Kretz et al. 705/14
 2008/0294556 A1 11/2008 Anderson 705/44
 2008/0305774 A1 12/2008 Ramakrishna 455/412.1
 2009/0098825 A1 4/2009 Huomo et al. 455/41.1
 2009/0106112 A1 4/2009 Dalmia et al.
 2009/0124234 A1 5/2009 Fisher et al.
 2009/0132362 A1 5/2009 Fisher et al.
 2009/0144161 A1 6/2009 Fisher
 2009/0227281 A1 9/2009 Hammad et al.
 2010/0057619 A1 3/2010 Weller et al.
 2010/0063895 A1 3/2010 Dominguez et al.
 2010/0105375 A1* 4/2010 Schroter 455/419
 2011/0320316 A1 12/2011 Randazza et al.

OTHER PUBLICATIONS

Office Action for U.S. Appl. No. 11/467,441 dated May 27, 2009.
 Office Action for U.S. Appl. No. 11/933,351 dated Jul. 8, 2009.
 Office Action for U.S. Appl. No. 11/948,903 dated Nov. 12, 2009.
 Office Action for U.S. Appl. No. 11/933,321 dated May 27, 2010.
 Office Action for U.S. Appl. No. 11/933,337 dated May 27, 2010.
 Office Action for U.S. Appl. No. 11/933,367 dated May 27, 2010.
 Office Action for U.S. Appl. No. 12/592,581 dated Jun. 4, 2010.
 Office Action for U.S. Appl. No. 11/939,821 dated Aug. 17, 2010.
 Office Action for U.S. Appl. No. 11/933,351 dated Aug. 18, 2010.
 Marsh, David. "Get Smart." EDN 48.6 (2003): 61-8. Hoover's Company Profiles; ProQuest Central. Web. Oct. 5, 2012.
 Deena, M. Amato. "Mobile Rewards." Chain Store Age 82.5 (2006): 160, 161, 163. Hoover's Company Profiles; ProQuest Central. Web. Oct. 5, 2012.
 "ViVOTEch to Demonstrate Industry's First End-to-End Near Field Communication (NFC) Solution at the NRF show." Business Wire: 1. Jan. 16, 2006. Business Dateline; Hoover's Company Profiles; ProQuest Central. Web. Oct. 5, 2012.

* cited by examiner

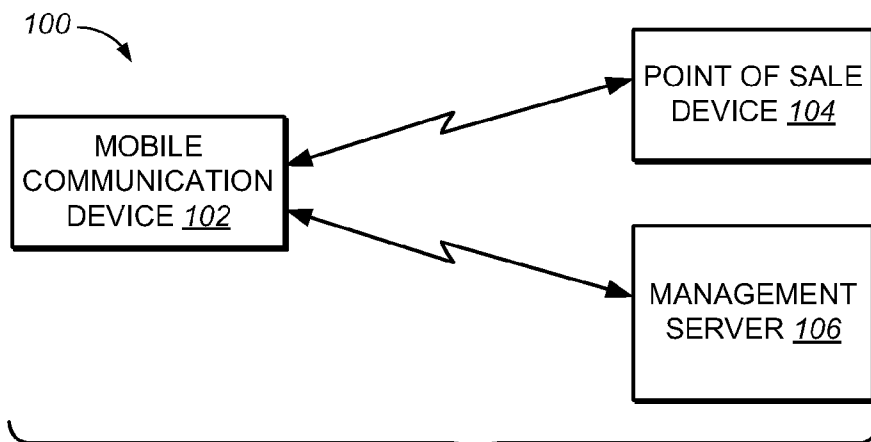

FIG. 1

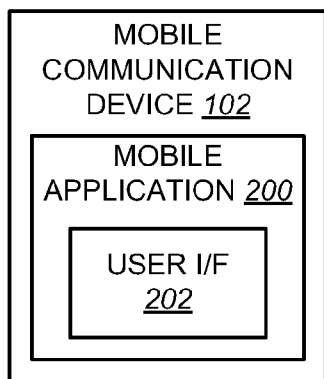

FIG. 2

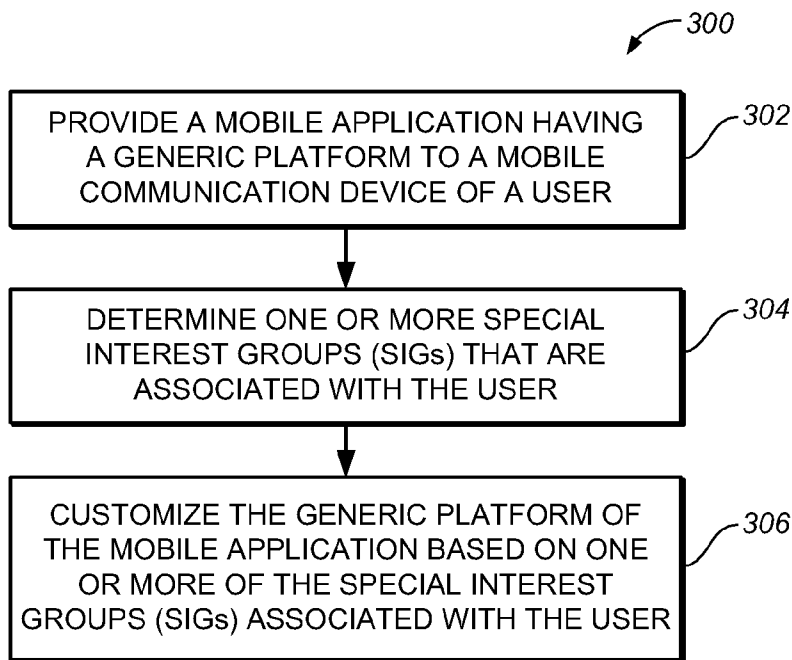
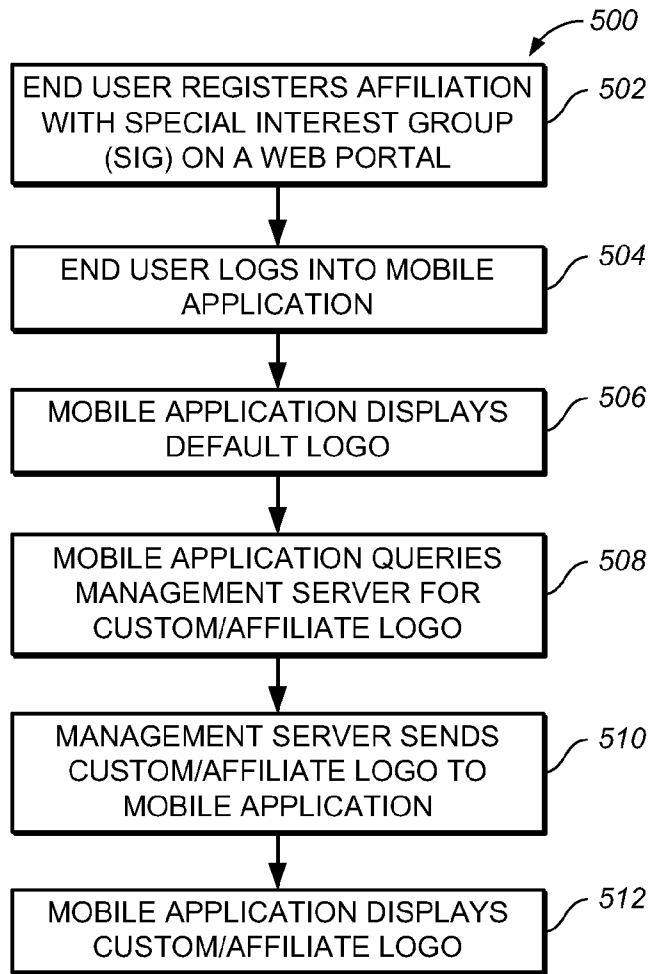
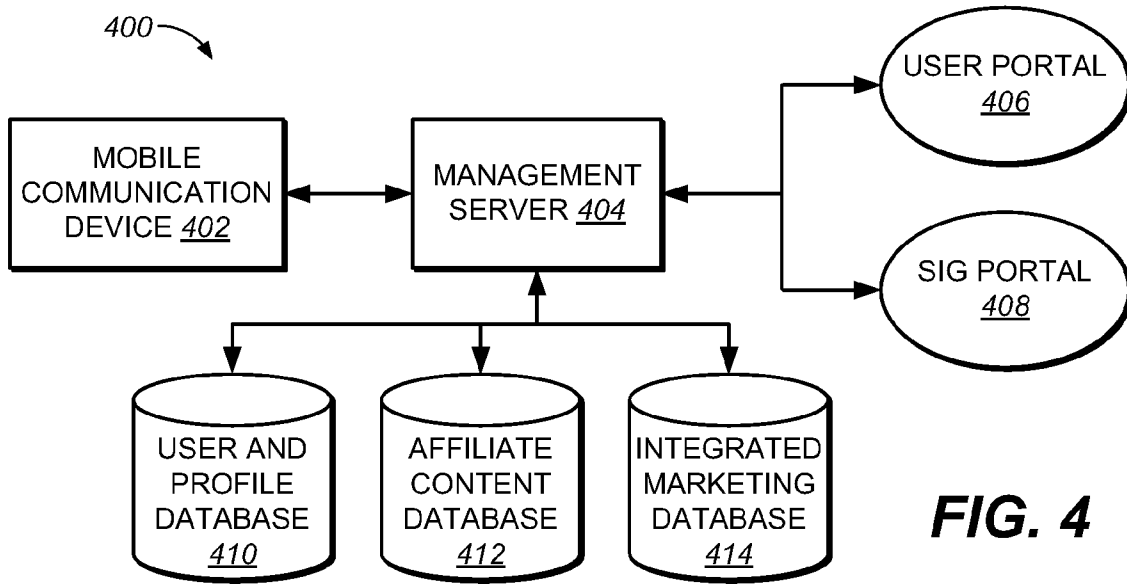

FIG. 3



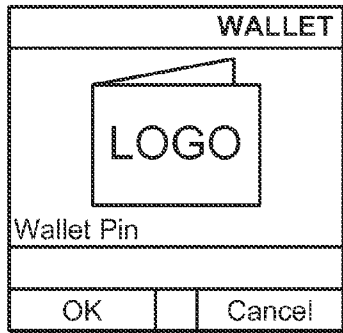

FIG. 6

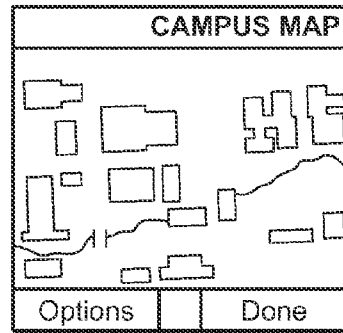
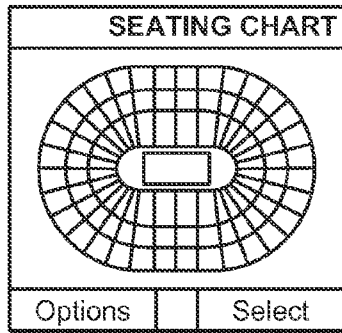

FIG. 9

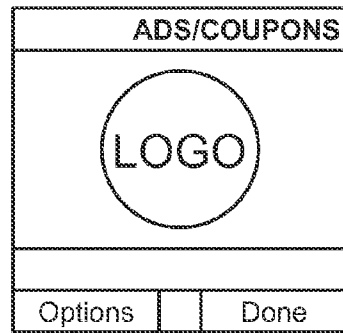
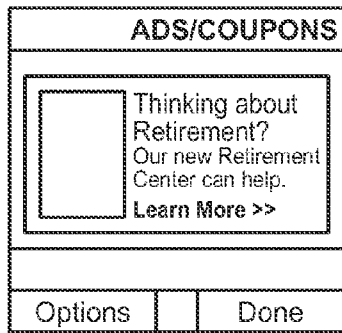
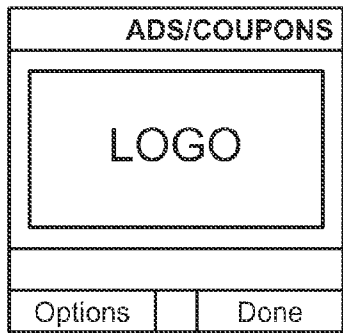

FIG. 7

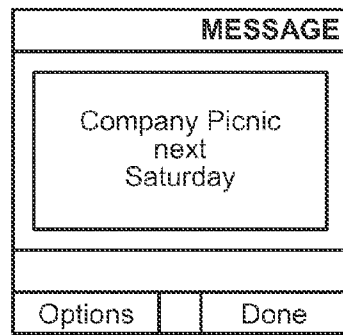
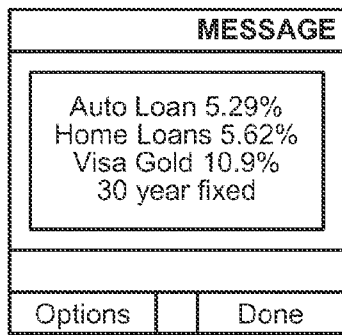
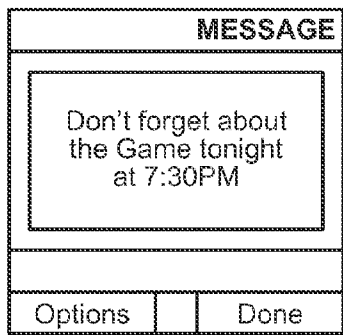
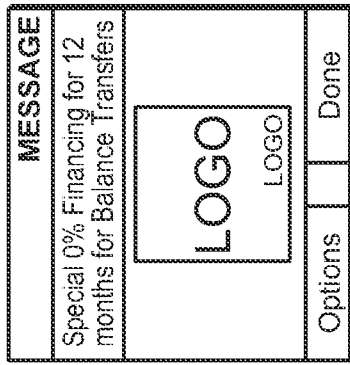
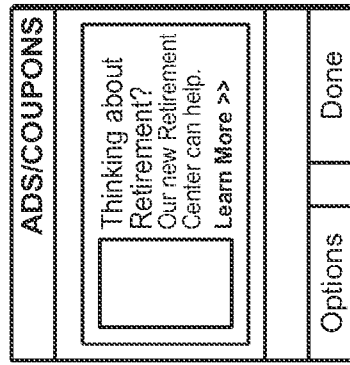

FIG. 8



Messages



Ads/
Coupons

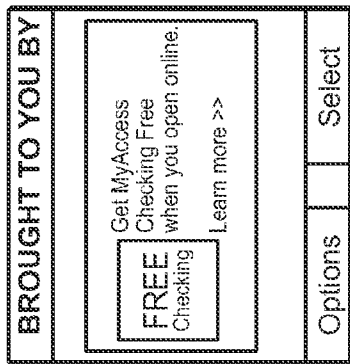
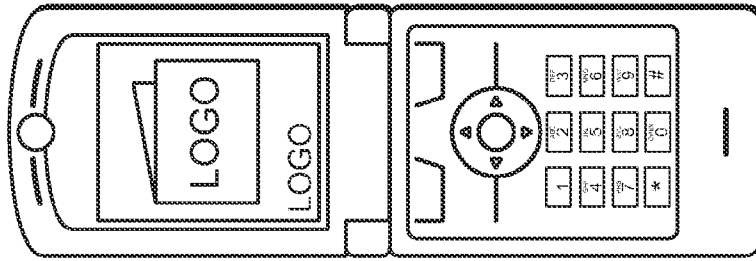

Landing
Screen

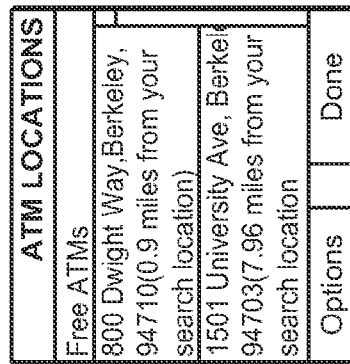

ATM
Locations

FIG. 10A

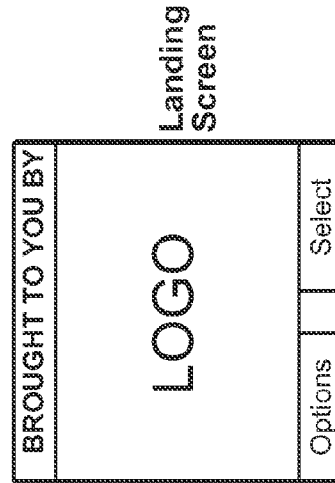
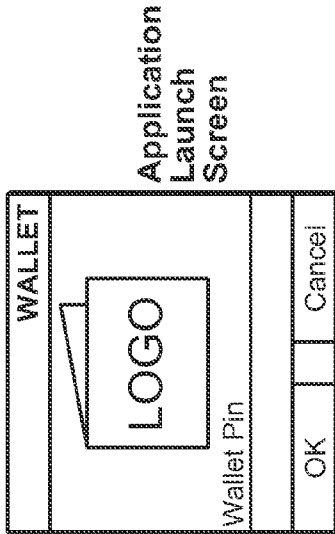
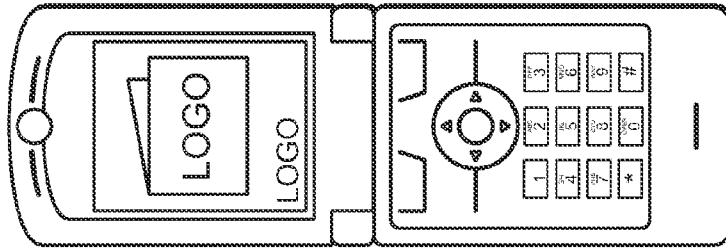
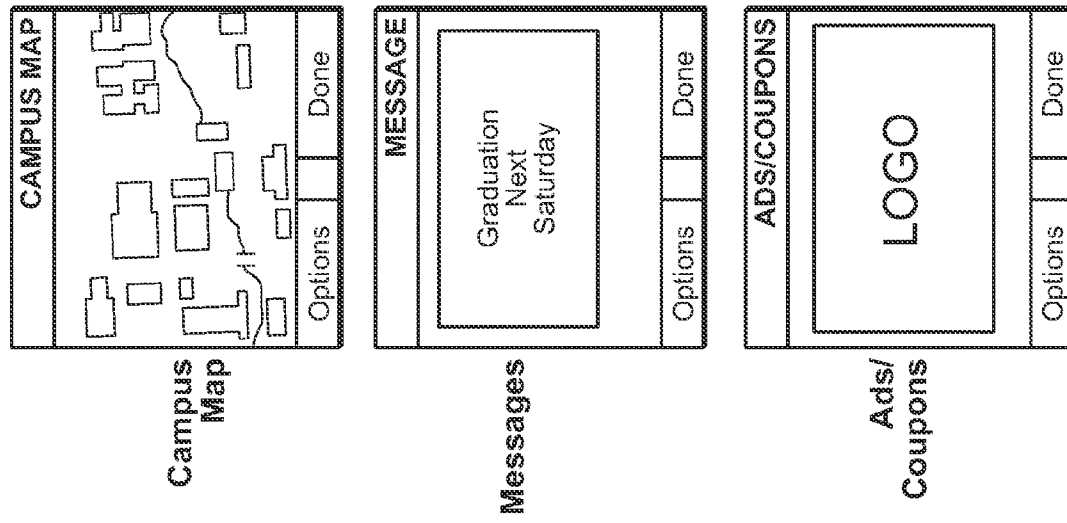
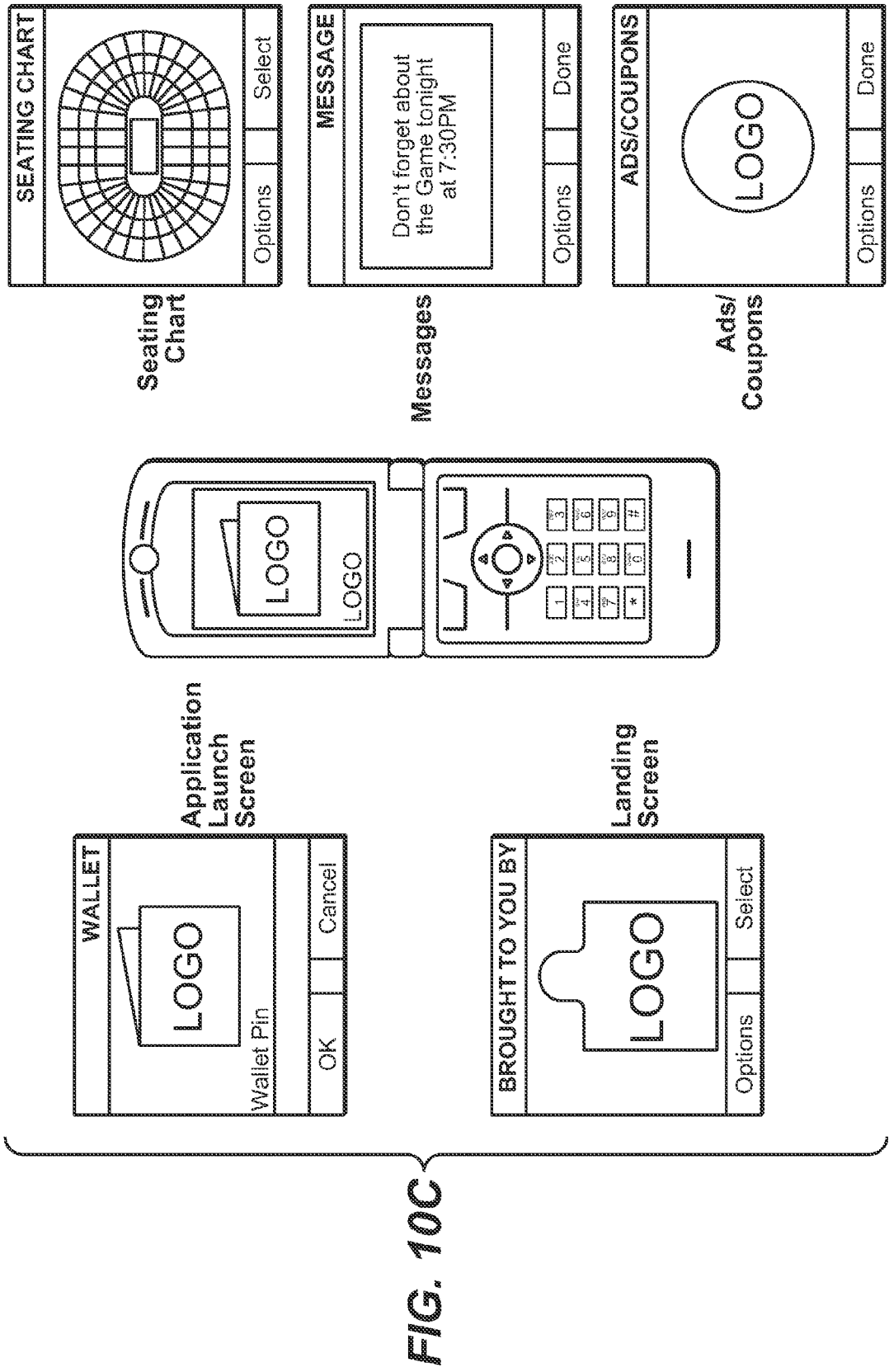
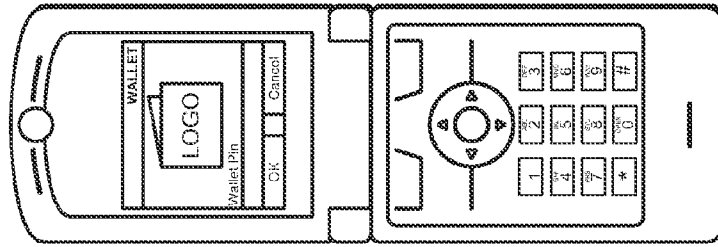
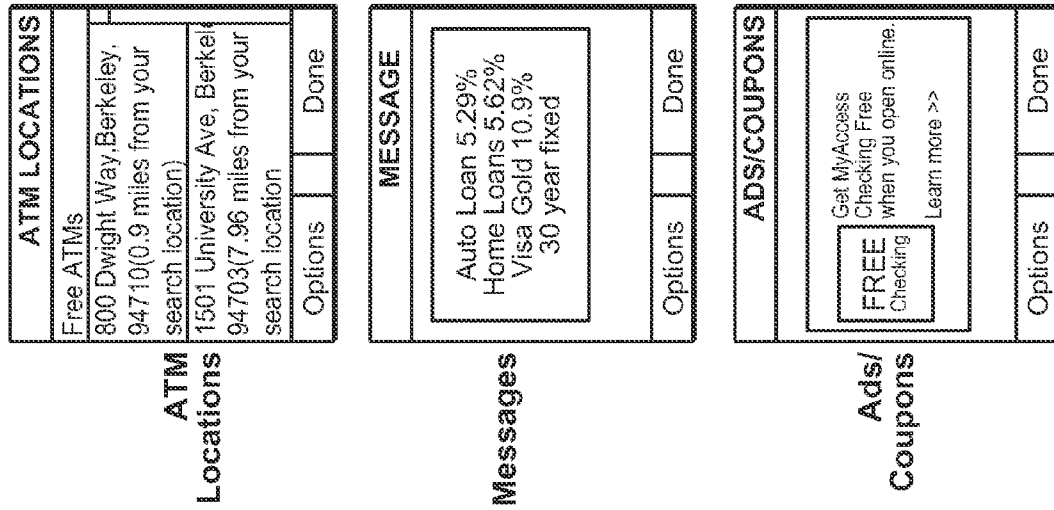
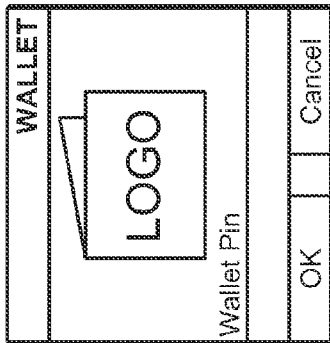

FIG. 10B





Application Launch Screen



Landing Screen

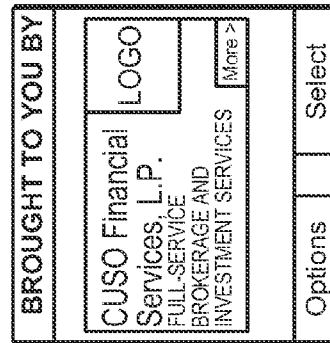

FIG. 10D

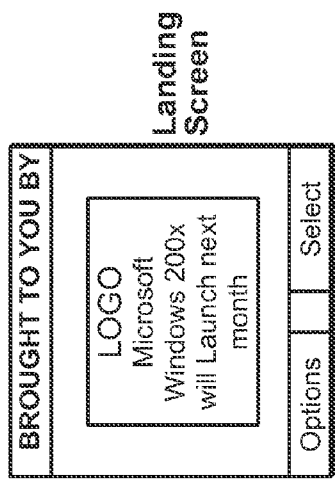
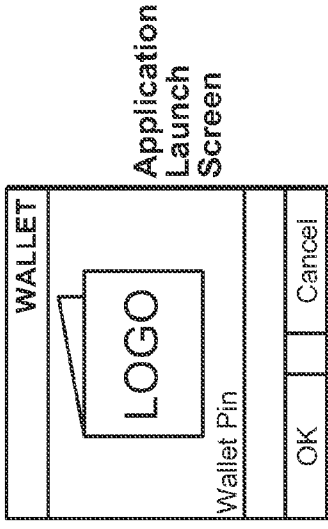
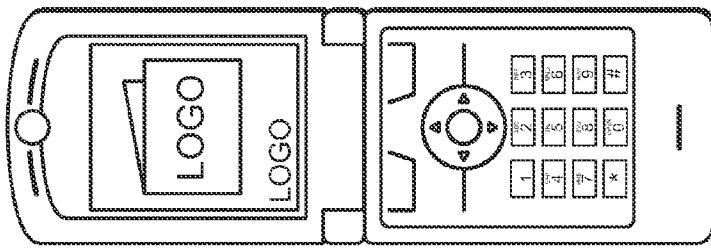
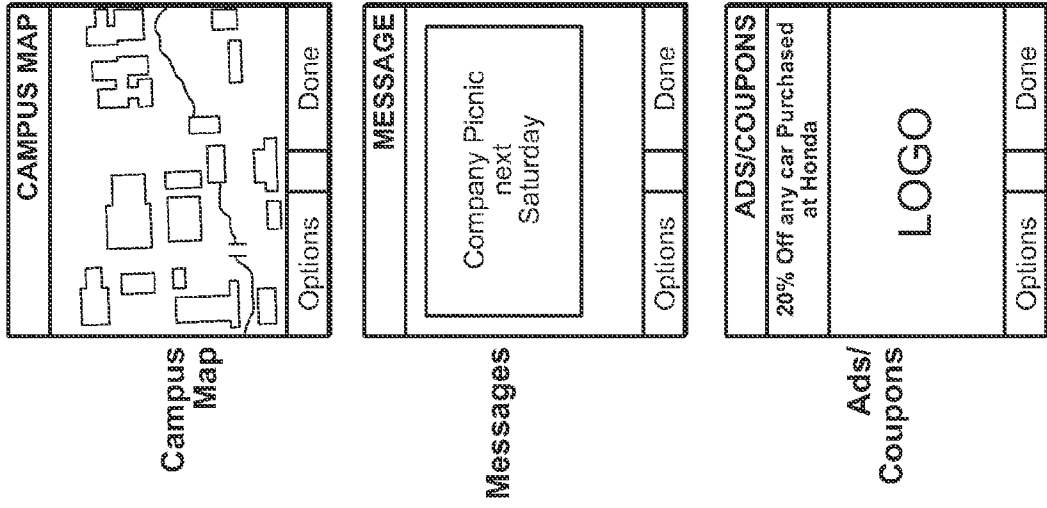

FIG. 10E

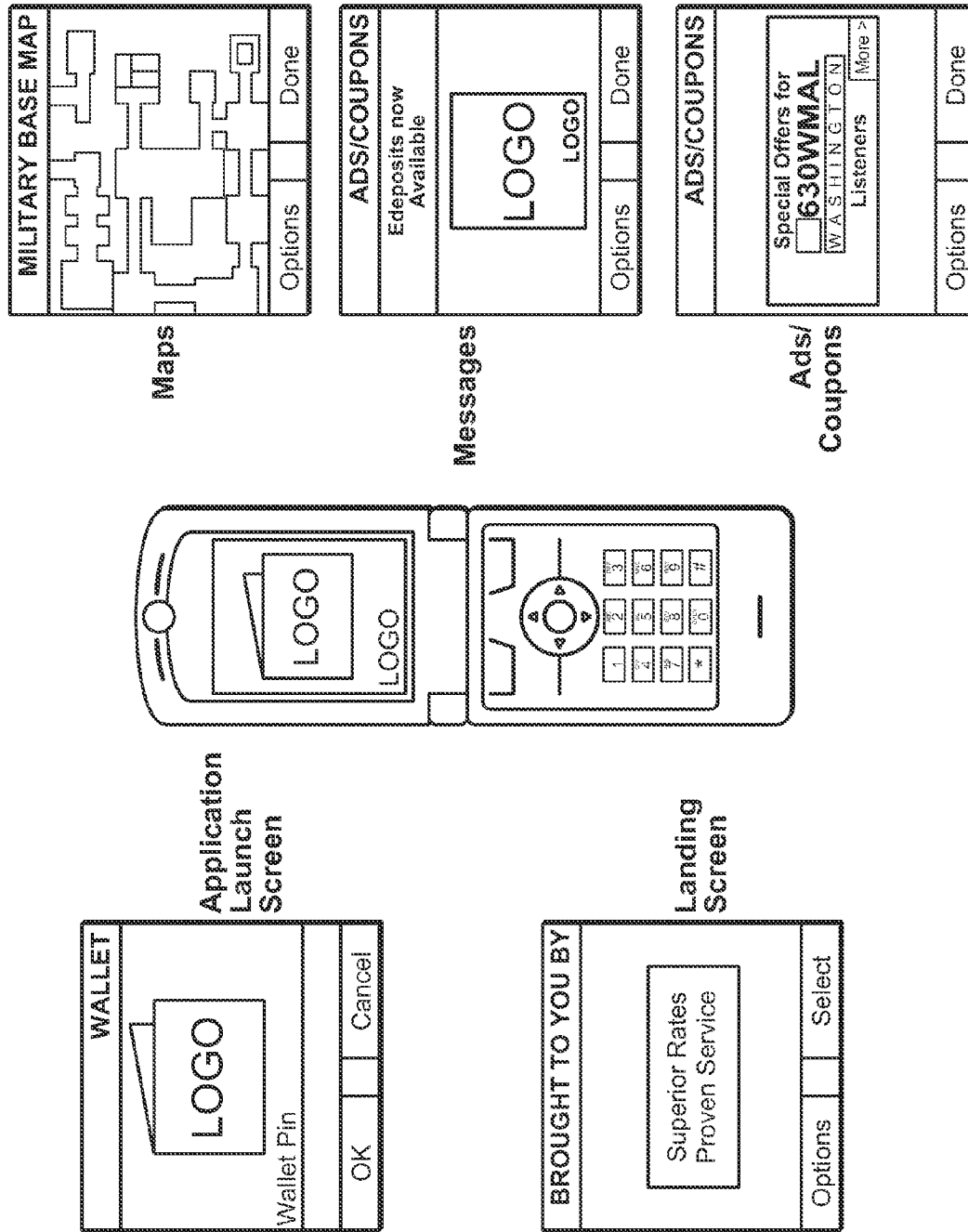

FIG. 10F

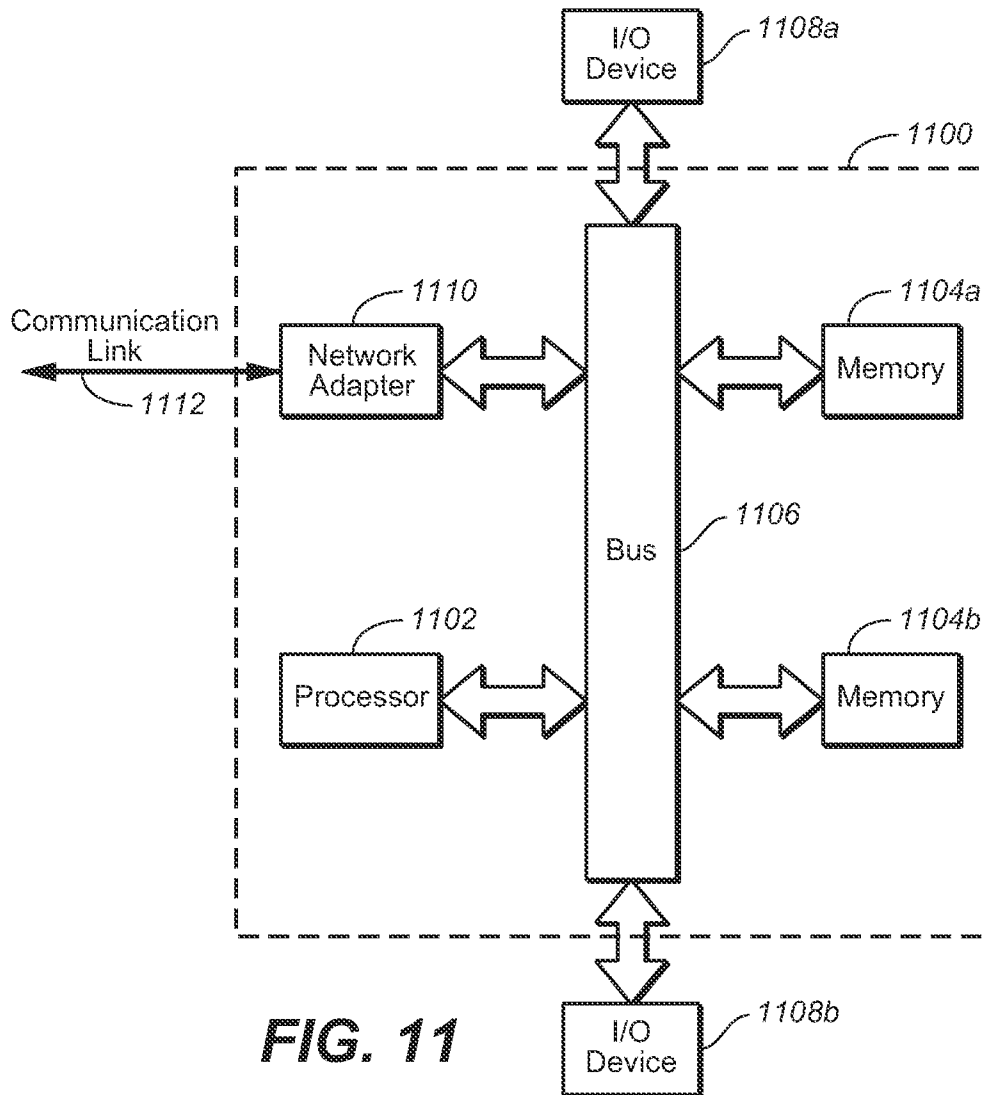

FIG. 11

CUSTOMIZED MOBILE APPLICATIONS FOR SPECIAL INTEREST GROUPS

FIELD OF INVENTION

The present invention relates to data communications and wireless devices.

BACKGROUND OF THE INVENTION

Mobile communication devices—e.g., cellular phones, personal digital assistants, and the like—are increasingly being used to conduct payment transactions (e.g., through mobile wallet applications) as described in U.S. patent application Ser. No. 11/933,351, entitled “Method and System For Scheduling A Banking Transaction Through A Mobile Communication Device”, and U.S. patent application Ser. No. 11/467,441, entitled “Method and Apparatus For Completing A Transaction Using A Wireless Mobile Communication Channel and Another Communication Channel, both of which are incorporated herein by reference. Such payment transactions can include, for example, purchasing goods and/or services, bill payments, and transferring funds between bank accounts.

In the mobile communication device space, delivering separate, customized mobile applications to mobile communication devices can be quite expensive in terms of cost and memory. For example, in the United States, AT&T recently announced that their mobile communication device platform will only support up to two mobile wallet applications. Such constraints, as well as limited device memory, limit the number of customized applications that an end user can run on a mobile communication device.

BRIEF SUMMARY OF THE INVENTION

In general, in one aspect, this specification describes a method for customizing a mobile application running on a mobile communication device of a user. The method includes providing the mobile application to the mobile communication device of the user, the mobile application having a generic platform; determining a special interest group (SIG) that is affiliated with the user; and customizing the generic platform of the mobile application based on information specific to the special interest group (SIG) that is affiliated with the user.

Particular implementations can include one or more of the following features. Customizing the generic platform of the mobile application can comprise displaying one or more of a logo, advertisement, coupon, alert, notification, or map that is associated with the special interest group (SIG) through the mobile application running on the mobile communication device. The special interest group (SIG) can be one of a university, corporation, military, government, sports team, or alumni association. The generic platform of the mobile application can be customizable by a plurality of different special interest groups (SIGs). The generic platform of the mobile application can comprise a generic user interface having default screens, controls, or logos that are changeable based on an affiliation of the user to the plurality of different special interest groups (SIGs). Customizing the generic platform of the mobile application can comprise updating only content that is being displayed through the mobile application. Customizing the generic platform of the mobile application can comprise customizing a number of modules that are presented to users through the mobile application. The modules can comprise one or more of a money management module

that permits a user to access account information from a financial institution, a what’s nearby module that permits a user to find points of interest (POI) and directions, a rewards module that permits a user to keep track of reward or loyalty cards, a ticket module that permits a user to purchase a ticket for an event, and an options module that permits a user to change the look-and-feel of the mobile application. The mobile communication device can be one of a cellular phone or a wireless personal digital assistant (PDA).

In general, in another aspect, this specification describes a system including a management server to provide a mobile application to a mobile communication device of a user, in which the mobile application has a generic platform. The management server further determines a special interest group (SIG) that is affiliated with the user, and customizes the generic platform of the mobile application based on information specific to the special interest group (SIG) that is affiliated with the user.

The details of one or more implementations are set forth in the accompanying drawings and the description below. Other features and advantages will be apparent from the description and drawings, and from the claims.

BRIEF DESCRIPTION OF THE DRAWINGS

FIG. 1 illustrates a block diagram of a communication system including a mobile communication device and a management server in accordance with one implementation.

FIG. 2 illustrates one implementation of the mobile communication device of FIG. 1.

FIG. 3 illustrates one implementation of a method for customizing a mobile application running on a mobile communication device.

FIG. 4 illustrates a block diagram of a communication system including a mobile communication device and a management server in accordance with one implementation.

FIG. 5 illustrates one implementation of a method for customizing a mobile application with a custom/affiliate logo of a special interest group (SIG).

FIG. 6 illustrates an example custom/affiliate logo of a special interest group (SIG) that can be displayed on a mobile communication device.

FIG. 7 illustrates example advertisements/coupons of a special interest group (SIG) that can be displayed on a mobile communication device.

FIG. 8 illustrates example messages of a special interest group (SIG) that can be displayed on a mobile communication device.

FIG. 9 illustrates example maps of a special interest group (SIG) that can be displayed on a mobile communication device.

FIGS. 10A-10F illustrate example customization of a mobile application running on a mobile communication device.

FIG. 11 illustrates a block diagram of a communication system including a wireless mobile communication device and a management server in accordance with one implementation.

Like reference symbols in the various drawings indicate like elements.

DETAILED DESCRIPTION OF THE INVENTION

FIG. 1 illustrates one implementation of a communication system 100. The communication system 100 includes a handheld, wireless mobile communication device 102 a point-of-sale device 104 and a management server 106. In one imple-

mentation, the mobile communication device **102** includes a mobile application (discussed in greater detail below) that permits a user of the mobile communication device **102** to conduct payment transactions. Payment transactions can include, for example, using contactless payment technology at a retail merchant point of sale (e.g., through point of sale device **104**), using mobile/internet commerce (e.g., purchase tickets and products, etc.), storage of payment information and other digital artifacts (e.g., receipts, tickets, coupons, etc.), storage of banking information (payment account numbers, security codes, PIN's, etc.), and accessing banking service (account balance, payment history, bill pay, fund transfer, etc.), and so on. The mobile communication device **102** can be a cellular phone, a wireless personal digital assistant (PDA), or other wireless communication device.

FIG. 2 illustrates one implementation of the mobile communication device **102**. The mobile communication device **102** includes a mobile application **200** that (in one implementation) is provided to the mobile communication device **102** through a remote server (e.g., management server **106**). In one implementation, the mobile application is a mobile wallet application (e.g., the Blaze Mobile Wallet application) available from Mobile Candy Dish, Inc., of Alameda, Calif. In one implementation, the mobile application is a hosted service, as described in U.S. patent application Ser. No. 11/939,821, entitled "Method and System For Securing Transactions Made Through a Mobile Communication Device", which is incorporated herein by reference. In one implementation, the mobile application **200** is configured to send requests to the management server for artifacts based on user input, e.g., received through a keypad (not shown) of the mobile communication device **102**. Requests to the management server **106** can also be automated, via proximity-based services, e.g., consumer tapping (or in close proximity) an LBS/contactless/RFID enabled phone against a smart poster (RFID/Bluetooth/LBS enabled, etc.), kiosk, or other device.

As shown in FIG. 2, the mobile application **200** includes a user interface **202** that is displayable on a display of the mobile communication device **102**. In one implementation, the user interface **202** is a generic user interface (or platform) that can be customized based on one or more special interest groups (SIG) that are affiliated with a user of the mobile communication device **102**. In general, the user interface **202** can be customized to display, e.g., screens, logos, messages, maps, coupons, advertisements, and other information, as discussed in greater detail below. In one implementation, a special interest group (SIG) is an organization. For example, a special interest group can be a university, corporation, military, government, sports team, alumni association, and the like. These (and other SIGs) generally have a need to brand and customize mobile applications they either sponsor or associate their name to. This is mandated because SIGs tend to heavily invest in promoting their name and brand recognition. Co-branding the mobile application with well-known third party brands will facilitate community exposure, help drive consumer acceptance and adoption through viral marketing (inherent to the community) as well as marketing programs by the SIG.

Usually, the format used by the mobile application **200** remains reasonably constant over time in contrast to content, which typically changes on a regular basis based on time and the SIG. In one implementation, as content changes on a regular basis, a SIG uploads only the new content to the management server (e.g., management server **106**). Accordingly, when the mobile application **200** next accesses the content of the management server **106**, the management server **106** uploads the new (customized SIG) content (and

format if applicable) to the mobile application **200**. Subsequent uploads to the mobile application **200** can include only content since the format, in one implementation, is cached on the mobile communication device **102** after the first download. If the SIG desires to change the format at a subsequent time, the next upload to the mobile application **200** can include both the new layout format and any new content.

In one implementation, the mobile application **200** comprises a plurality of different modules, in which each module provides a specific function for a user. For example, the Blaze Mobile Wallet application provides the following example modules:

Money Management—A user can access account information (e.g., balance, transaction history, and so on) from banks and credit card financial institutions. A user can also pay bills, transfer funds (e.g., person-to-person, me-to-me same bank, and me-to-me different bank). A user can also have their paychecks directly deposited into in their mobile wallet, withdraw cash from ATM machines, or pick up cash at a redemption location. A user can also use a contactless debit card associated with their mobile wallet to buy products at participating contactless merchants and receive their transaction history in their mobile wallet in real-time.

What's Nearby—A user can find points of interest (POI), directions, and access maps using this module. For example, a user can find points of interest from over a dozen categories such as restaurants, shopping malls, golf courses, gas stations, regular merchants, theaters, ATM locations, and so on. With respect to directions and maps, a user can get turn-by-turn directions and a viewable map with zooming capability.

Rewards/Loyalty/Coupons—A user can keep track of reward/loyalty cards—e.g., frequently flyer account number, rental car reward membership, hotel reward membership, and the like—through the rewards module. In one implementation, a user can view, in real-time, a summary of all rewards (e.g., points accumulated) directly on a cellular phone. A user can also search for and store coupons on their mobile communication device for use during, e.g., a contactless purchase.

Tickets—This module permits a user to purchase tickets for e.g., movies, sport events, and other entertainment events, through their mobile communication device. A user can also view movie trailers and read reviews through their mobile communication device.

Options—Through this module a user can customize the look and feel of the mobile application, including setting the colors, graphics, logos, and so on. A user can also set a default payment method, send feedback, tell-a-friend, earn reward points, and the like.

The modules above are example modules. The mobile application can provide other modules to perform additional functions for a user over a mobile communication device—e.g., an additional module can include an Internet Purchase module that permits users to use their mobile communication device to purchase items over the Internet. In one implementation, a special interest group (SIG) can modify the number of modules that are available to a user (or users). For example, a particular special interest group (SIG) may only want to provide a rewards program to users, and therefore, the special interest group (SIG) can modify the mobile application **200** to present only a rewards module as described above. In general, a special interest group (SIG) can modify the mobile application **200** to provide any number and combination of modules to users.

FIG. 3 illustrates a method 300 for customizing a mobile application (e.g., mobile application 200) running on a mobile communication device. (e.g., mobile communication device 102). A mobile application having a generic platform is provided to a mobile communication device of a user (step 302). In one implementation, the mobile application is provided to the mobile communication device through a network—e.g., a public network (e.g., the Internet), a private network, or a voice communications network. The generic platform can comprise a generic user interface having default screens, controls, and/or logos. A determination is made (e.g., by management server 106) of one or more special interest groups (SIGs) that are associated with the user (step 304). In one implementation, the management server 306 queries a database (e.g., an affiliate content database) to determine which special interest groups (SIGs) that a given user is associated with. The generic platform of the mobile application is customized based on one or more of the special interest groups (SIGs) that are associated with the user (step 306).

In one implementation, association between a SIG and an end user is validated via an out-of-band process—e.g., a banking customer may have to specify their SIG and provide their SIG credentials (e.g., online banking userID/password) that are unique to the SIG. The management server validates the credentials with the SIG. Once the end user has been authenticated by the SIG, it will be possible to deliver the SIG's branding and messaging specifically to the end user. Such a technique minimizes the number of applications that need to be executed by a mobile communication device. For example, a single mobile application can be customized by a large number of different special interest groups (SIGs). In one implementation, the mobile application can be customized to display different screens, user interfaces and/or controls. Less memory is, therefore, required by a mobile communication device in order to support applications required by multiple special interest groups (SIGs).

FIG. 4 illustrates one implementation of a communication system 400. The communication system 400 includes a handheld, wireless mobile communication device 402, a management server 404, a user portal 406, and a special interest group (SIG) portal 408. In one implementation, the management server 404 is coupled to a user and profile database 410, an affiliate content database 412, and an integrated marketing database 414. In one implementation, the user and profile database 410 stores user profile information associated with each user—e.g., passwords, personal identification numbers (PINs), contact information, e-mail addresses, and the like; the affiliate content database 412 stores associations between special interest groups (SIGs) and users; and the integrated marketing database 414 stores artifacts (e.g., coupons, advertising, tickets, etc.) that can be sent to a user.

To enable the branding and customization of the mobile application (e.g., the mobile wallet application) running on the mobile communication device 402, in one implementation, various screens are designed based on meta-data (i.e., meta-data delivered (pulled or pushed) to the mobile communication device 402 based on the SIG). The core wallet screen can be the same for all subscribers—e.g., a login screen for all subscribers can have the same pre-defined format (controlling how content is displayed and permitted actions), and only the content is dynamically generated. The following screens, or category of screens, include (but are not limited to):

Logo—A community logo will display upon wallet launch. If a customer is not affiliated with a SIG, the default Blaze logo will be displayed.

Watermark—An almost transparent watermark image that does not to conflict with maps, wallpaper, etc.

Advertisements—Local advertisements from the community will be displayed instead of or in addition to general advertisements. If a customer is not affiliated with a SIG, general advertisements will be displayed.

Coupons—Coupons from the local community will be displayed instead of or in addition to general coupons. If a customer is not affiliated with a SIG, general coupons will be displayed.

Events—Community events will be displayed. If a customer is not affiliated with a SIG, general events will be displayed such as information about MCD (Mobile Candy Dish), new wallet features, etc.

Alerts—Community alerts will be displayed. If a customer is not affiliated with a SIG, general alerts will be displayed.

Maps—A community map will be displayed. Some examples of a community map include a campus map for a university, seating chart for a sports team, corporate campus map (particularly for large campuses like Google, Microsoft, etc.), and so forth.

In some cases, a special interest group (SIG) may be involved in the content approval process. In such an implementation, in order to deliver meta-data to the mobile communication device based on input from the SIG, the end-user's account (e.g., walletID, etc.) is associated with a SIG. The SIG will access a portal (web-based or otherwise) (e.g., SIG portal 408) that enables the SIG to control, publish, etc., content associated to the SIG on the management server 404. In one implementation, one or more screens queries the management server 404 for dynamic content (media, text, logo, sort order, etc.). The query can include (but is not limited to) the end-users walletID. Using a look-up table in the management server 404 or the affiliate content database 412, it is possible to determine the associated SIG. The management server 404 can then internally determine the appropriate content (including media, etc.) to respond to the mobile application running on the mobile communication device 402. These result sets can be cached on the mobile communication device 402 for future use to improve performance (as needed).

Logos

FIG. 5 illustrates a method 500 for providing a logo to a mobile communication device (e.g., mobile communication device 402) for display through a mobile application running on the mobile communication device. An end user registers an affiliation with a special interest group (SIG) on a web portal (e.g., user portal 406) (step 502). Thereafter, the end user logs into the mobile application running on the mobile communication device (step 504). Upon initial login, the mobile application displays a default logo (step 506). The mobile application queries a management server (e.g., management server 404) for any custom/affiliate logos that is associated with the user (step 508). The management server determines which special interest groups (SIGs) that the user is affiliated with, and sends a custom/affiliate logo to the mobile application running on the mobile communication device (step 510). FIG. 6 illustrates an example logo of a University that can be sent to a mobile application. In response to receiving the custom/affiliate logo, the mobile application displays the custom/affiliate logo (step 512). In one implementation, the default logo is replaced with the custom/affiliate logo in response to the user logging off, and re-logging into the mobile application.

Integrated Mobile Marketing Insertion

In one implementation, an advertising manager application running on the management server 404 inserts advertisements (based on advertisement insertion order) into Ad Engine (or 3rdParty Ad Delivery platform). The advertising

manager application specifies specific advertisements with targeting parameters of special interest groups (SIGs) (among other targeting parameters as specified by, e.g., an advertising agency) and displays these advertisements in the mobile application.

Integrated Mobile Marketing (Advertising and Coupons) Delivery

In one implementation, advertising and/or coupons can be sent to a mobile application based on one or more special interest groups (SIGs) that a user is affiliated with. In one implementation, an end user registers affiliation with a special interest group (SIG) through a web portal (e.g., user portal 406). The management system 406 can validate the affiliation out-of-band. The end user logs into mobile application, and the mobile application queries the management server 404 for any advertisements or coupons by providing a screenID (a unique screen identifier). The management server 404 determines that the user has an affiliation to a special interest group (SIG) and appends the SIGID (a unique SIG identifier) to the target parameters. A query including the targeting parameters is forwarded to an advertising engine (or 3rdParty). The advertising engine responds with the appropriate URL to the advertising object that best meets the advertising criteria (e.g., age, gender, geographic location, proximity to retail store, shopping list, transaction history, etc.). In one implementation, the mobile application queries advertisements based on the URL returned. FIG. 7 illustrates example advertisements/coupons that can be displayed through a mobile application running on a mobile communication device.

Alerts and Notification

In one implementation, alerts and notifications can be sent to a mobile application based on one or more special interest groups (SIGs) that a user is affiliated with. In one implementation, a notification manager application running on the management server 404 inserts alerts (based on an insertion order) into a notification engine associated with the management server 404 (or a third party notification delivery platform). The notification manager application associates the notifications (text, etc.) with one or more SIGIDs (among other targeting parameters as specified by, e.g., an advertising agency). In one implementation, the notification engine queries the user and profile database 410, and determines a list of walletIDs (of end users) that match the target delivery criteria. For each end-user identified, the management server 404 determines a notification mode (e.g., SMS/text messaging, e-mail, or both) and a delivery window (time of day, etc.). These criteria are used to send the notification (or alerts) to the end-user. FIG. 8 illustrates example alerts and notifications that can be displayed through a mobile application running on a mobile communication device.

Campus Maps

In one implementation, maps can be sent to a mobile application based on one or more special interest groups (SIGs) that a user is affiliated with. In one implementation, an end user registers affiliation with a special interest group (SIG) through a web portal (e.g., user portal 406). The management system 404 can validate the affiliation of the user to the special interest group (SIG) out-of-band. The end user logs into the mobile application, and the mobile application queries the management server 404 for an affiliate campus map. The management server 404 determines that the end user has an affiliation with a special interest group (SIG), and responds to the query with a campus map associated with the special interest group (SIG). The campus map is cached in a memory of the mobile communication device 402, and the mobile application running on the mobile communication device 402

displays the campus map. FIG. 9 illustrates example maps/seating charts that can be displayed through a mobile application running on a mobile communication device.

FIGS. 10A-10F illustrate example screens, messages, advertisements, and/or coupons that can be displayed through a mobile application running on a mobile communication device. In particular, FIG. 10A illustrates example customization of a mobile application for a bank; FIG. 10B illustrates example customization of a mobile application for a university; FIG. 10C illustrates example customization of a mobile application for a sports team; FIG. 10D illustrates example customization of a mobile application for a credit union; FIG. 10E illustrates example customization of a mobile application for a corporation; and FIG. 10F illustrates example customization of a mobile application for a military campus. In general, the same generic platform of a mobile application can be used to deliver the different screens, messages, advertisements, and/or coupons shown in FIGS. 10A-10F.

One or more of method steps described above can be performed by one or more programmable processors executing a computer program to perform functions by operating on input data and generating output. Generally, the invention can take the form of an entirely hardware embodiment, an entirely software embodiment or an embodiment containing both hardware and software elements. In one implementation, the invention is implemented in software, which includes but is not limited to firmware, resident software, microcode, etc. Furthermore, the invention can take the form of a computer program product accessible from a computer-usable or computer-readable medium providing program code for use by or in connection with a computer or any instruction execution system. For the purposes of this description, a computer-usable or computer readable medium can be any apparatus that can contain, store, communicate, propagate, or transport the program for use by or in connection with the instruction execution system, apparatus, or device. The medium can be an electronic, magnetic, optical, electromagnetic, infrared, or semiconductor system (or apparatus or device) or a propagation medium. Examples of a computer-readable medium include a semiconductor or solid state memory, magnetic tape, a removable computer diskette, a random access memory (RAM), a read-only memory (ROM), a rigid magnetic disk and an optical disk. Current examples of optical disks include compact disk-read only memory (CD-ROM), compact disk-read/write (CD-R/W) and DVD.

FIG. 11 illustrates a data processing system 1100 (e.g., a mobile communication device) suitable for storing and/or executing program code. Data processing system 1100 includes a processor 1102 coupled to memory elements 1104A-B through a system bus 1106. In other implementations, data processing system 1100 may include more than one processor and each processor may be coupled directly or indirectly to one or more memory elements through a system bus. Memory elements 1104A-B can include local memory employed during actual execution of the program code, bulk storage, and cache memories that provide temporary storage of at least some program code in order to reduce the number of times the code must be retrieved from bulk storage during execution. As shown, input/output or I/O devices 1108A-B (including, but not limited to, keyboards, displays, pointing devices, etc.) are coupled to data processing system 1100. I/O devices 1108A-B may be coupled to data processing system 1100 directly or indirectly through intervening I/O controllers (not shown).

In one implementation, a network adapter 1110 is coupled to data processing system 1100 to enable data processing system 1100 to become coupled to other data processing

systems or remote printers or storage devices through communication link 1112. Communication link 1112 can be a private or public network. Modems, cable modems, and Ethernet cards are just a few of the currently available types of network adapters.

Although the present invention has been particularly described with reference to implementations discussed above, various changes, modifications and substitutes are can be made. Accordingly, it will be appreciated that in numerous instances some features of the invention can be employed without a corresponding use of other features. Further, variations can be made in the number and arrangement of components illustrated in the figures discussed above.

What is claimed is:

1. A method for customizing a non-browser based mobile application running on a mobile communication device of a user, the method comprising:

sending a request from the non-browser based mobile application to login to a special interest group (SIG), the request received at a management server;

sending a request from the non-browser based mobile application to the management server for customized information associated with the (SIG) for display within a specific non-browser based mobile application generated screen after login;

receiving customized information associated with the (SIG) from the management server after login for display within the specific non-browser based mobile application generated screen; and

displaying the customized information associated with the (SIG) within the specific non-browser based mobile application generated screen;

wherein the non-browser based mobile application generated screen includes one or more of a logo, advertisement, coupon, alert, notification, or map that is customizable based on an affiliation of the user to the special interest group (SIG).

2. The method of claim 1, wherein the special interest group (SIG) is one of a university, corporation, military, government, sports team, bank, credit union or alumni association.

3. The method of claim 1, wherein the application generated screen of the mobile application is customizable by a plurality of different special interest groups (SIGs).

4. The method of claim 3, wherein the application generated screen of the mobile application—has default screens, controls, or logos that are customizable based on an affiliation of the user to the plurality of different special interest groups (SIGs).

5. The method of claim 1, wherein the customized information only customizes content that is being displayed through execution of the mobile application.

6. The method of claim 1, wherein the customized information customizes one or more modules that are presented to users through the mobile application.

7. The method of claim 6, wherein the one or more modules are selected from the group consisting of:

a money management module that permits a user to access account information from a financial institution,

a location based information module that permits a user to find points of interest (POI) and directions,

a rewards module that permits a user to keep track of reward or loyalty cards,

a ticket module that permits a user to purchase a ticket for an event, and

an options module that permits a user to change the look-and-feel of the mobile application executing on the mobile communication device.

8. The method of claim 1, further comprising receiving customized information from the SIG at the management server.

9. The method of claim 1, wherein the request is triggered by user input at the mobile communication device.

10. The method of claim 1, wherein the request is triggered automatically based on the location of the user and the mobile communication device interacting with one of a smart poster, kiosk or other contactless device.

11. The method of claim 1, further wherein the SIG allows for a execution of a mobile device payment transaction selected from the group consisting of contactless payment, ticketing, Internet commerce, storage of banking information, storage of payment information and other digital artifacts, and accessing banking services.

12. A system for customizing a non-browser based mobile application running on a mobile communication device of a user, the system comprising:

a mobile communication device associated with a user, the mobile communication device executing the non-browser based mobile application having a non-browser based application generated screen and

sends a request from the non-browser based mobile application to login to a special interest group (SIG);

sends a request after login from the non-browser based mobile application to management server for display of customized information associated with the (SIG) within a specific non-browser based mobile application generated screen;

receives customized information associated with the (SIG) from the management server for display within a specific non-browser based mobile application generated screen associated with the (SIG) and

displays customized information associated with the (SIG) within the specific non-browser based mobile application generated screen;

wherein the non-browser based mobile application generated screen includes one or more of a logo, advertisement, coupon, alert, notification, or map that is customizable based on an affiliation of the user to the special interest group (SIG).

13. The system of claim 12, wherein the special interest group (SIG) is one of a university, corporation, military, government, sports team, bank, credit union, or alumni association.

14. The system of claim 12, wherein the customized information sent by the management server may customize the application generated screen of the mobile application in accordance with a plurality of different special interest groups.

15. The system of claim 14, wherein the application generated screen includes default screens, controls, or logos that may be customized by the customized information sent by the management server, the customization-based on an affiliation of the user to the plurality of different special interest groups.

16. The system of claim 12, wherein the customized information sent by the management server customizes the application generated screen of the mobile application by updating only content that is being displayed through execution of the mobile application.

17. The system of claim 12, wherein the mobile communication device is one of a cellular phone or a wireless personal digital assistant (PDA).

11

18. A method for customizing a mobile communication device, the method comprising:

delivering customized advertising information from an advertising engine executing at a server for display within a specific non-browser based application generated screen of the mobile application running on the mobile communication device, the customized advertising information based on an affiliation of a user associated with the mobile communication device and a special interest group (SIG);

delivering coupons from the advertising engine executing at the server for display within a specific non-browser based application generated screen of the mobile application running on the mobile communication device, the customized advertising information based on the affiliation of the user with the special interest group;

delivering notifications for display within a specific non-browser based application generated screen of the mobile application running on the mobile communication device, wherein the notifications are processed by an application executing at the mobile communication device, the notifications based on the affiliation of the user with the special interest group; and

delivering location based information for display within a specific non-browser based application generated screen of the mobile application running on the mobile communication device, wherein the location based information concerns the affiliation of the user with the special interest group;

12

wherein the non-browser based mobile application generated screen includes one or more of a logo, advertisement, coupon, alert, notification, or map that is customizable based on an affiliation of the user to the special interest group (SIG).

19. The method of claim **18**, wherein the customized advertising information includes a logo of the special interest group.

20. The method of claim **18**, wherein the location based information includes a map.

21. The method of claim **18**, wherein the advertising engine processes targeting parameters that correspond to one or more advertising criteria to deliver the customized advertising information.

22. The method of claim **21**, wherein the targeting parameters are selected from the group consisting of age, gender, location, proximity to a retailer, a virtual shopping list, and payment history.

23. The method of claim **18**, wherein the coupons correspond to a URL that may be queried by a mobile communication device.

24. The method of claim **18**, wherein the customized advertising information correspond to a URL that may be queried by a mobile communication device.

25. The method of claim **18**, wherein the notifications correspond to a target delivery criteria.

26. The method of claim **25**, wherein the target delivery criteria correspond to a delivery mode.

27. The method of claim **25**, wherein the target delivery criteria correspond to a delivery window.

* * * * *